

MEDIAN QUASIMORPHISMS ON CAT(0) CUBE COMPLEXES AND THEIR CUP PRODUCTS

BENJAMIN BRÜCK, FRANCESCO FOURNIER-FACIO, AND CLARA LÖH

ABSTRACT. Cup products provide a natural approach to access higher bounded cohomology groups. We extend vanishing results on cup products of Brooks quasimorphisms of free groups to cup products of median quasimorphisms, i.e., Brooks-type quasimorphisms of group actions on CAT(0) cube complexes. In particular, we obtain such vanishing results for groups acting on trees and for right-angled Artin groups. Moreover, we outline potential applications of vanishing results for cup products in bounded cohomology.

1. INTRODUCTION

The aim of this article is to extend vanishing results for cup products in the bounded cohomology of free groups to group actions on CAT(0) cube complexes. We first explain the context of these results.

Bounded cohomology of groups is the cohomology of the complex of bounded equivariant functions on the simplicial resolution (Section 2). The boundedness condition enables exciting applications to the geometry of manifolds [31], stable commutator length [12], group actions on the circle [27], and rigidity theory [11]. However, boundedness causes a lack of excision; therefore, despite a functional-analytic version of the resolution calculus [39], bounded cohomology remains difficult to compute in general.

A key example is given by non-abelian free groups F . The bounded cohomology of (the one-dimensional groups!) F is known to be non-trivial in degrees 2 (via quasimorphisms, Section 2.3) and 3 (via hyperbolic geometry [57]). However, it is unknown whether the higher-degree bounded cohomology $H_b^n(F; \mathbb{R})$ for $n \geq 4$ is non-trivial [10, Question 16.3]. A related open problem is to decide whether epimorphisms of groups induce injective maps on the level of bounded cohomology in all degrees. An affirmative answer to the latter question would lead to non-triviality of the bounded cohomology of non-abelian free groups in degrees ≥ 4 , which in turn would have consequences for large classes of geometrically defined groups [37, 24].

The cup product on bounded cohomology sheds some light on both problems by producing classes in high degrees from lower degrees (for the second problem, this is explained in Appendix A). A natural starting point are non-trivial classes in degree 2: Bounded cohomology in degree 2 is closely

Date: December 1, 2023. Benjamin Brück was supported by the Deutsche Forschungsgemeinschaft (DFG, German Research Foundation) under Germany's Excellence Strategy EXC 2044 - 390685587, Mathematics Münster: Dynamics-Geometry-Structure. Francesco Fournier-Facio has been supported by the Herchel Smith Postdoctoral Fellowship Fund. Clara Löh has been supported by the CRC 1085 *Higher Invariants* (Universität Regensburg, funded by the DFG).

2020 *Mathematics Subject Classification.* Primary: 18G90, 20E08, 20F67, 20F65.

Key words and phrases. bounded cohomology, cup product, CAT(0) cube complexes, quasimorphisms, RAAGs.

related to quasimorphisms, which are relevant in geometric group theory [2], knot theory [45], and symplectic geometry [53]. More precisely, if $f: \Gamma \rightarrow \mathbb{R}$ is a quasimorphism of a group Γ , then the simplicial cochain \widehat{f} associated with f defines a class $[\delta^1 \widehat{f}]$ in $H_b^2(\Gamma; \mathbb{R})$ (Section 2.3).

1.1. Brooks quasimorphisms. For free groups, all bounded cohomology classes in degree 2 come from quasimorphisms, and a key example of quasimorphisms on free groups are Brooks quasimorphisms [7] (Example 2.4). The cup product on the bounded cohomology of free groups was studied independently by Bucher–Monod [8] and Heuer [34], who proved that many cup products of quasimorphism classes are trivial. Recently, Amontova–Bucher combined these techniques:

Theorem 1.1 (Amontova–Bucher [1]). *Let F be a free group, let $w \in F$ and let H_w be the corresponding (big) Brooks quasimorphism. Then, for every $n \geq 1$ and every $\zeta \in H_b^n(F; \mathbb{R})$, the cup product $[\delta^1 \widehat{H_w}] \cup \zeta$ is trivial in $H_b^{2+n}(F; \mathbb{R})$.*

These results partially generalise to other types of quasimorphisms on free groups [34, 20, 1], but it is not clear whether they hold for *all* quasimorphisms on free groups. In the present paper, we will focus on Brooks quasimorphisms and their generalisations. Brooks quasimorphisms and their bounded cohomology classes have been generalised in many directions [16, 25, 26, 30, 2, 17]. Thus, the following (vague) question arises:

Question 1.2. Which Brooks-type quasimorphisms produce trivial cup products in bounded cohomology?

For example, this was recently answered for de Rahm quasimorphisms on surface groups, a continuous analogue of Brooks quasimorphisms [46].

In the present paper, we answer Question 1.2 for *median quasimorphisms*, which are Brooks-type quasimorphisms, defined for groups acting on CAT(0) cube complexes. We use the framework of equivariant bounded cohomology [44, 40] to state our results in a more general, vastly applicable way.

Remark 1.3. Before moving forward with the statements of results, we point out that cup products in bounded cohomology can very well be non-trivial. E.g., this happens for cup powers of the Euler class of Thompson’s group T [11, 28, 22, 50] and for certain direct products [43, 21]. In particular, this can occur for groups acting on CAT(0) cube complexes (Example 3.19).

1.2. Groups acting on trees. We start by stating our results for groups acting on trees, where the statements are stronger and parallel the case of the free group more closely. Given an action of a group Γ on a simplicial tree T , an oriented geodesic segment s in T , and a base vertex x , one associates a counting quasimorphism, the *median quasimorphism* $f_{s,x}: \Gamma \rightarrow \mathbb{R}$ (see Section 4 for the relevant definitions). These quasimorphisms were defined by Monod and Shalom [51] and are a dynamical analogue of Brooks quasimorphisms: If Γ is a free group, T is a Cayley tree of Γ , and s is the geodesic segment $[e, w]$ in T for $w \in \Gamma$, then the median quasimorphism $f_{s,e}$ coincides with the Brooks quasimorphism H_w . These quasimorphisms have proven very useful in the study of rigidity properties of groups acting on

trees [51, 52] and they admit an easy-to-check dynamical criterion for triviality [38]. Since the equivariant point of view is more natural for our purposes, we consider *median quasimorphisms* f_s of the action $\Gamma \curvearrowright T$, which dispense of the choice of base vertex (Definition 2.8).

Our first main result is the answer to Question 1.2 for median quasimorphisms on groups acting on trees:

Theorem 1.4 (Theorem 4.3). *Let $\Gamma \curvearrowright T$ be a group action on a tree T . Let s be an oriented geodesic segment in T , and let f_s be the corresponding median quasimorphism of $\Gamma \curvearrowright T$. Then, for every $n \geq 1$ and every $\zeta \in H_{\Gamma,b}^n(T; \mathbb{R})$, the cup product $[\delta^1 f_s] \cup \zeta \in H_{\Gamma,b}^{2+n}(T; \mathbb{R})$ is trivial.*

Here $H_{\Gamma,b}^n(T; \mathbb{R})$ denotes the Γ -equivariant bounded cohomology of T , which we tacitly identify with its vertex set. Upon choosing a base vertex $x \in T$ we obtain the median quasimorphism $f_{s,x}$, and then Theorem 1.4 states that the corresponding class $[\delta^1 \widehat{f_{s,x}}] \in H_b^2(\Gamma; \mathbb{R})$ has trivial cup product with every class that can also be described via the action of Γ on T . In the case of amenable stabilisers, all classes in $H_b^*(\Gamma; \mathbb{R})$ are of this form:

Corollary 1.5 (Corollary 4.4). *With the notation of Theorem 1.4, suppose that vertex stabilizers are amenable and let x be a base vertex. Then, for every $n \geq 1$ and every $\zeta \in H_b^n(\Gamma; \mathbb{R})$, the cup product $[\delta^1 \widehat{f_{s,x}}] \cup \zeta \in H_b^{2+n}(\Gamma; \mathbb{R})$ is trivial.*

Via Bass–Serre Theory, the class of groups to which Corollary 1.5 applies coincides with fundamental groups of graphs of groups with amenable vertex groups (see Remark 4.5). This includes the following examples, which show that Theorem 1.4 applies much further than to free groups: virtually free groups, Baumslag–Solitar groups, torus knot groups, generalized Baumslag–Solitar groups, amalgamated products and HNN-extensions of amenable groups.

While our proof is based on the same blueprint as the proofs by Bucher, Monod, Heuer, and Amontova, it has the advantage of avoiding heavyweight combinatorics and the complex of aligned chains. In particular, it admits a straightforward generalisation to actions on CAT(0) cube complexes (Section 1.3). The aligned cochain complex was introduced by Bucher and Monod [9], and it significantly simplifies computations in bounded cohomology of groups acting on trees [8, 1]. However, it is currently unknown whether this complex can be generalised suitably to actions on other objects [9]. Heuer’s approach [34] is based on involved combinatorics and might be cumbersome to adapt to actions on higher-dimensional objects.

1.3. Groups acting on CAT(0) cube complexes. Now we let Γ act on a finite-dimensional CAT(0) cube complex X . One can generalize oriented geodesic segments in trees to \mathcal{H} -segments [15, 17], i.e., to sequences of tightly nested halfspaces in X . We use such sequences to define *median quasimorphisms* on Γ analogously to the case of trees (see Section 3 for the relevant definitions). These are the overlapping version of the effective quasimorphisms on RAAGs defined by Fernós–Forrester–Tao [17]. The generalization is more subtle than it may look at first sight: Unlike the non-overlapping

case [17], the natural definition does not lead to a quasimorphism in general (Examples 3.12 and 3.14). We show that we do obtain quasimorphisms under our running assumption that the CAT(0) cube complex X is finite-dimensional and has finite staircase length (Proposition 3.16).

The situation for cup products is more delicate than in the case of trees: We exhibit median quasimorphisms whose cup product is *not* trivial (Example 3.19). However, we can give sufficient conditions that ensure that the cup product vanishes. Once again, we state the result for the corresponding median classes in equivariant bounded cohomology; the definitions of the quasimorphisms f_s and of non-transversality are given in Section 3.3.

Theorem 1.6 (Theorems 3.23 and 3.25). *Let Γ be a group acting on a finite-dimensional CAT(0) cube complex X with finite staircase length. Let s be an \mathcal{H} -segment in X , and let f_s be the corresponding median quasimorphism of $\Gamma \curvearrowright X$. Then, for every class $\zeta \in H_{\Gamma,b}^n(X; \mathbb{R})$ that is non-transverse to the orbit Γs , the cup product $[\delta^1 f_s] \cup \zeta \in H_{\Gamma,b}^{2+n}(X; \mathbb{R})$ is trivial.*

In particular, this holds if $\zeta = [\delta^1 f_r]$ for another \mathcal{H} -segment r and the first and last halfspaces of s and r have non-transverse orbits.

As previously mentioned, we use the hypotheses that X is finite-dimensional and has finite staircase length to ensure that f_s be a quasimorphism. We use them also crucially in the proof, in order to guarantee that the explicit primitive we construct is bounded.

As a concrete example, we examine the case of right-angled Artin groups:

Corollary 1.7 (Corollary 5.5). *Let $\Gamma = A(G)$ be a RAAG acting on the universal covering X of its Salvetti complex with base vertex x . Let s, r be \mathcal{H} -segments in X such that the labels of the first and last halfspaces in s and the labels of the first and last halfspaces in r are not connected by an edge in G . Then $[\delta^1 \widehat{f_{s,x}}] \cup [\delta^1 \widehat{f_{r,x}}] = 0 \in H_b^4(\Gamma; \mathbb{R})$.*

There is a wealth of such genuinely median classes: We show that many of these classes $[\delta^1 \widehat{f_{s,x}}]$ are non-trivial in bounded cohomology (Section 5.3) and that the median quasimorphisms $f_{s,x}$ are not at bounded distance to canonical pullbacks of Brooks quasimorphisms (Section 5.4). We hope that these classes will shed new light on the bounded cohomology of RAAGs and their subgroups, potentially leading to an understanding analogous to that of quasimorphisms of free groups via Brooks quasimorphisms [29, 33, 20].

Recently, Marasco proved that for many quasimorphism classes of free groups also higher order vanishing occurs: The corresponding Massey triple products in bounded cohomology are zero [47]. In the meantime, the techniques from the present article have been used to show triviality of Massey triple products in the context of median quasimorphisms [35].

Finally, in addition to the application of cup product vanishing in bounded cohomology outlined in Appendix A, let us mention the following open problem: It is unknown whether – in analogy with the cup length bound for the Lusternik–Schnirelmann category – the cup length for the bounded cohomology is a lower bound for the amenable category [13, Remark 3.17]. Again, an interesting test case is given by non-abelian free groups, relating this question to the above problems on the bounded cohomology of free groups.

Organization of the paper. Basics on bounded cohomology, equivariant bounded cohomology, and quasimorphisms are collected in Section 2. Median quasimorphisms for actions on CAT(0) cube complexes and their cup products in bounded cohomology are studied in Section 3. We specialise to the tree case in Section 4 and to the right-angled Artin case in Section 5. Appendix A outlines the connection to the Lex-problem.

Acknowledgements. We wish to thank Matthew Cordes, Talia Fernós, Elia Fioravanti and Nicolas Monod for helpful discussions, as well as Sofia Amontova, Michelle Bucher, and Marco Moraschini for discussions on cup products and Lex. Moreover, we would like to thank Franziska Hofmann for spotting a gap in an earlier version of this paper, and the anonymous referee for several helpful comments, including a fix of the gap.

2. BOUNDED COHOMOLOGY

We recall basic notions concerning bounded cohomology and quasimorphisms and refer the reader to the literature for more details and proofs [31, 39, 49, 23]. We will only be interested in the case of discrete groups and trivial real coefficients.

2.1. Bounded cohomology of groups. Let Γ be a discrete group. We consider the complex $\ell^\infty(\Gamma^{*+1}, \mathbb{R})$ of normed $\mathbb{R}[\Gamma]$ -modules, equipped with the simplicial coboundary operators. The subcomplex of Γ -invariants is denoted by $C_b^*(\Gamma; \mathbb{R}) := \ell^\infty(\Gamma^{*+1}, \mathbb{R})^\Gamma$. The *bounded cohomology* of Γ (with trivial real coefficients) is defined as

$$H_b^*(\Gamma; \mathbb{R}) := H^*(C_b^*(\Gamma; \mathbb{R})).$$

The canonical inclusion $\ell^\infty(\Gamma^{*+1}, \mathbb{R}) \hookrightarrow \text{Map}(\Gamma^{*+1}, \mathbb{R})$ from bounded to ordinary cochains induces a natural transformation between bounded cohomology and ordinary cohomology, the *comparison map*

$$\text{comp}_\Gamma^*: H_b^*(\Gamma; \mathbb{R}) \rightarrow H^*(\Gamma; \mathbb{R}).$$

The kernel of comp_Γ^2 is related to quasimorphisms (Section 2.3).

The usual formula gives a cup product on bounded cohomology:

$$\begin{aligned} \cup: C_b^p(\Gamma; \mathbb{R}) \otimes_{\mathbb{R}} C_b^q(\Gamma; \mathbb{R}) &\rightarrow C_b^{p+q}(\Gamma; \mathbb{R}) \\ f \otimes g &\mapsto ((\gamma_0, \dots, \gamma_{p+q}) \mapsto f(\gamma_0, \dots, \gamma_p) \cdot g(\gamma_p, \dots, \gamma_{p+q})) \\ \cup: H_b^p(\Gamma; \mathbb{R}) \otimes_{\mathbb{R}} H_b^q(\Gamma; \mathbb{R}) &\rightarrow H_b^{p+q}(\Gamma; \mathbb{R}) \\ [f] \otimes [g] &\mapsto [f \cup g] \end{aligned}$$

These operations are well-defined and satisfy the usual equations with respect to the simplicial coboundary operator. In particular, we have

$$\delta^{p+q}(f \cup g) = \delta^p f \cup g + (-1)^p \cdot f \cup \delta^q g.$$

2.2. Equivariant bounded cohomology. Equivariant bounded cohomology is a bounded version of equivariant cohomology [40, 44].

Definition 2.1. Let $\Gamma \curvearrowright S$ be an action of a group Γ on a set S . We write

$$C_{\Gamma,b}^*(S; \mathbb{R}) := \ell^\infty(S^{*+1}, \mathbb{R})^\Gamma,$$

where $\ell^\infty(S^{*+1}, \mathbb{R})$ carries the simplicial coboundary operator and the Γ -action given by

$$(s_0, \dots, s_n) \mapsto f(\gamma^{-1} \cdot s_0, \dots, \gamma^{-1} \cdot s_n)$$

for all $\gamma \in \Gamma$, $f \in \ell^\infty(S^{n+1}, \mathbb{R})$. The Γ -equivariant bounded cohomology of S (with trivial real coefficients) is defined as

$$H_{\Gamma,b}^*(S; \mathbb{R}) := H^*(C_{\Gamma,b}^*(S; \mathbb{R})).$$

For an action $\Gamma \curvearrowright X$ on a CAT(0) cube complex with vertex set V (Section 3.1), we will also write

$$H_{\Gamma,b}^*(X; \mathbb{R}) := H_{\Gamma,b}^*(V; \mathbb{R}).$$

The usual formula gives a cup product on equivariant bounded cohomology: Let $\Gamma \curvearrowright S$ be a group action and let $p, q \in \mathbb{N}$. Then

$$\begin{aligned} \cup: C_{\Gamma,b}^p(S; \mathbb{R}) \otimes_{\mathbb{R}} C_{\Gamma,b}^q(S; \mathbb{R}) &\rightarrow C_{\Gamma,b}^{p+q}(S; \mathbb{R}) \\ f \otimes g &\mapsto ((s_0, \dots, s_{p+q}) \mapsto f(s_0, \dots, s_p) \cdot g(s_p, \dots, s_{p+q})) \\ \cup: H_{\Gamma,b}^p(S; \mathbb{R}) \otimes_{\mathbb{R}} H_{\Gamma,b}^q(S; \mathbb{R}) &\rightarrow H_{\Gamma,b}^{p+q}(S; \mathbb{R}) \\ [f] \otimes [g] &\mapsto [f \cup g] \end{aligned}$$

are well-defined and satisfy the usual equations with respect to the simplicial coboundary operator.

Equivariant and ordinary bounded cohomology are related via pullbacks of orbit maps. Namely for every $x \in S$, the *orbit map* $o_x: \Gamma \rightarrow S, \gamma \mapsto \gamma \cdot x$ induces a cochain map $C_{\Gamma,b}^*(S; \mathbb{R}) \rightarrow C_b^*(\Gamma; \mathbb{R})$. We denote the induced map in bounded cohomology by

$$o_x^* := H_{\Gamma,b}^*(o_x; \mathbb{R}): H_{\Gamma,b}^*(S; \mathbb{R}) \rightarrow H_b^*(\Gamma; \mathbb{R}).$$

The map o_x^* is compatible with the cup products.

In general, this map o_x^* is neither injective nor surjective. It is an isomorphism under some additional hypotheses on the stabilizers:

Theorem 2.2 ([23, Theorem 4.23]). *Let $\Gamma \curvearrowright S$ be a group action with amenable stabilizers. Then for every $x \in S$, the orbit map*

$$o_x^*: H_{\Gamma,b}^*(S; \mathbb{R}) \rightarrow H_b^*(\Gamma; \mathbb{R})$$

is an isomorphism.

Similarly, one can also consider the case of uniformly boundedly acyclic actions [41, Section 5.5].

2.3. Quasimorphisms. The exact part of bounded cohomology in degree 2 can be described in terms of quasimorphisms.

Definition 2.3 (quasimorphism). Let Γ be a group. A *quasimorphism* of Γ is a function $f: \Gamma \rightarrow \mathbb{R}$ whose *defect*

$$D(f) := \sup_{\gamma, \lambda \in \Gamma} |f(\gamma) + f(\lambda) - f(\gamma \cdot \lambda)|$$

is finite. A quasimorphism is called *trivial* if it is a sum of a homomorphism and a bounded function.

We recall an important example of quasimorphisms of the free group: the Brooks quasimorphisms [12, 2.3.2]. These counting quasimorphisms are at the basis of the generalisations explored in this paper.

Example 2.4 (Brooks quasimorphisms). Let F be a free group with a free generating set S and let $w \in F$ be a reduced word over $S \cup S^{-1}$. For an element $\gamma \in F$, we denote by $C_w(\gamma)$ the number of copies of w that appear in a reduced expression for γ . The (*big*) *Brooks quasimorphism* for w is

$$\begin{aligned} H_w: F &\rightarrow \mathbb{R} \\ \gamma &\mapsto C_w(\gamma) - C_{w^{-1}}(\gamma). \end{aligned}$$

Then $D(H_w) \leq 3 \cdot (|w| - 1)$, where $|w|$ denotes the length of w .

Another option is to define $c_w(\gamma)$ as the maximal number of *non-overlapping* copies of w that appear in a reduced expression for γ . This leads to the (*small*) *Brooks quasimorphism* for w , denoted by h_w . The advantage of the small Brooks quasimorphism is that $D(h_w) \leq 2$, which gives a bound independent of w . This makes h_w more suitable for quantitative applications such as computations of stable commutator length. If w is *non-self-overlapping* (i.e., there is no reduced expression $w = uvu$ with a non-empty word u), then $H_w = h_w$.

For later reference, we note the following property of Brooks quasimorphisms:

Lemma 2.5. *Let F be a non-abelian free group and $w, w' \in F$. Then H_w is at bounded distance from $H_{w'}$ if and only if $w = w'$.*

Note that F must be non-abelian for this to hold. If $F = \langle a \rangle \cong \mathbb{Z}$, then $H_{a^n}(a^k) = \text{sign}(kn) \cdot (|k| - |n| + 1)$ whenever $|k| \geq |n|$, so every Brooks quasimorphism is close to the identity or to minus the identity.

Proof. Assume that H_w is at bounded distance from $H_{w'}$. We need to show that this implies $w = w'$.

Let S be a symmetrized basis of F , so by assumption $|S| \geq 4$. Let $a \in S$ be such that w does not start with a^{-1} , and w' does neither start nor end with a . Let $a^{-1} \neq b \in S$ be such that w does not end with b^{-1} , and w' does not end with b . Let $k \geq 1$ be larger than the length of both w and w' . Then $a^k w b^k$ is a cyclically reduced word, and we claim that $\overline{H_w}(a^k w b^k) > 0$. For this, it suffices to notice that w^{-1} cannot be a subword of $(a^k w b^k)^n$ for any $n \geq 1$. Indeed, no occurrence of w^{-1} can overlap with w [20, Lemma 3.14], and also by assumption w^{-1} cannot end with a (because w does not start with a^{-1}) and w^{-1} cannot start with b (because w does not end with b^{-1}).

It follows that $\overline{H_{w'}(a^k w b^k)} > 0$ as well, in particular w' must occur as a subword of $(a^k w b^k)^n$ for some $n > 0$. However, w' does neither start nor end with a , and it does not end with b . Since moreover k is larger than the length of w' , we conclude that w' must occur as a subword of w .

Swapping the roles of w and w' , we see that w must occur as a subword of w' , which completes the proof. \square

Every quasimorphism $f: \Gamma \rightarrow \mathbb{R}$ defines a Γ -invariant 1-cochain via

$$\widehat{f}: (\gamma_0, \gamma_1) \mapsto f(\gamma_0^{-1} \cdot \gamma_1).$$

By construction, $\delta^1 \widehat{f}$ is bounded – that is, \widehat{f} is a *quasicocycle* – and thus $\delta^1 \widehat{f}$ defines a class in $H_b^2(\Gamma; \mathbb{R})$. In fact, such classes form the kernel of the comparison map in degree 2 [23, Proposition 2.8]:

Proposition 2.6. *Let Γ be a group. Then the sequence*

$$\begin{aligned} 0 \rightarrow \text{QM}(\Gamma)/\text{QM}_0(\Gamma) &\rightarrow H_b^2(\Gamma; \mathbb{R}) \xrightarrow{\text{comp}_\Gamma^2} H^2(\Gamma; \mathbb{R}) \\ [f] &\mapsto [\delta^1 \widehat{f}] \end{aligned}$$

is exact, where $\text{QM}(\Gamma)$ is the space of quasimorphisms on Γ and $\text{QM}_0(\Gamma)$ the subspace of trivial quasimorphisms.

Moreover, every element in $\text{QM}(\Gamma)$ admits up to bounded functions a unique homogeneous representative (i.e., a quasimorphism that is a homomorphism on all cyclic subgroups).

In particular, if the comparison map in degree 2 is trivial, then every bounded cohomology class is represented by a quasimorphism. This is of course the case for groups Γ with $H^2(\Gamma; \mathbb{R}) \cong 0$, e.g., for free groups. Therefore, the study of quasimorphisms is central to the study of the bounded cohomology of free groups. More generally, we have:

Proposition 2.7 ([13, Corollary 5.4], [40, Example 4.7]). *Let Γ be a group acting on a tree with amenable vertex stabilizers. Then the comparison map comp_Γ^n is trivial for all $n \geq 1$.*

2.4. Quasimorphisms of group actions. In view of the cocycle description of quasimorphisms, we can speak of quasimorphisms of group actions:

Definition 2.8 (quasimorphism of a group action). Let $\Gamma \curvearrowright S$ be a group action on a set S . A *quasimorphism of $\Gamma \curvearrowright S$* is a function $f: S \times S \rightarrow \mathbb{R}$ that is Γ -invariant (with respect to the diagonal action on $S \times S$) and has finite *defect*

$$D(f) := \|\delta^1 f\|_\infty = \sup_{x,y,z \in S} |f(y,z) - f(x,z) + f(x,y)|.$$

Remark 2.9. If f is a quasimorphism of a group action $\Gamma \curvearrowright S$, then $\delta^1 f$ is a bounded cocycle in $C_{\Gamma,b}^2(S; \mathbb{R})$ and thus defines a class $[\delta^1 f] \in H_{\Gamma,b}^2(S; \mathbb{R})$. By construction, the set of all such classes coincides with the kernel of the comparison map $H_{\Gamma,b}^2(S; \mathbb{R}) \rightarrow H_\Gamma^2(S; \mathbb{R})$.

Remark 2.10 (from group actions to quasimorphisms on groups). Let $f: S \times S \rightarrow \mathbb{R}$ be a quasimorphism of a group action $\Gamma \curvearrowright S$. If $x \in S$, then

$$\begin{aligned} f_x: \Gamma &\rightarrow \mathbb{R} \\ \gamma &\mapsto f(x, \gamma \cdot x) \end{aligned}$$

is a quasimorphism of Γ in the sense of Definition 2.3. By construction,

$$[\delta^1 \widehat{f}_x] = o_x^*([\delta^1 f]) \in H_b^2(\Gamma; \mathbb{R}),$$

where $o_x: \Gamma \rightarrow S$ is the orbit map of x and \widehat{f}_x is the Γ -invariant 1-cochain defined by f_x .

If x and x' lie in the same orbit, then the classes in $H_b^2(\Gamma; \mathbb{R})$ differ only by the conjugation action. The conjugation action is trivial on $H_b^2(\Gamma; \mathbb{R})$: in degree 2 this can be derived from the exact sequence in Proposition 2.6, the triviality of the conjugation action on $H^2(\Gamma; \mathbb{R})$, and the fact that homogeneous quasimorphisms are conjugation invariant; more generally, one can prove the triviality of the conjugation action on bounded cohomology by a quantitative version of the proof for the classical case [43, Lemma A.2]. Therefore, we obtain $[\delta^1 \widehat{f}_x] = [\delta^1 \widehat{f}_{x'}]$ in $H_b^2(\Gamma; \mathbb{R})$.

Examples of quasimorphisms of group actions will be given in Section 3 and Section 5.

3. MEDIAN QUASIMORPHISMS

We define median quasimorphisms on groups acting on CAT(0) cube complexes and their associated equivariant bounded cohomology classes. These classes do not have vanishing cup products in general (Example 3.19), but we show that they do under additional compatibility hypotheses.

3.1. Preliminaries on CAT(0) cube complexes. We recall the necessary basics on CAT(0) cube complexes and median graphs [56, 54, 5]:

A cube complex X is *non-positively curved* if the links of its vertices are flag complexes. Informally, this means that as soon as there is a corner of a possible cube of dimension at least 3 in X , there is an actual cube with this corner. We refer to this as the *link condition*. A CAT(0) *cube complex* is a simply connected non-positively curved cube complex.

Throughout this section, we will consider the following situation:

Setup 3.1. Fix a CAT(0) cube complex X with vertex set V and an action of a group Γ on X by combinatorial automorphisms. We denote the k -skeleton of X by $X(k)$; in particular, $X(0) = V$. The 1-skeleton $X(1)$ is an undirected graph equipped with the ℓ^1 -metric D . Given $x, y \in V$, we denote by $[x, y]$ the union of all combinatorial geodesics (represented by sequences of vertices) from x to y ; such sets are called *intervals*.

The most important property of $X(1)$ is that it is a *median graph*: for every triple of points $x, y, z \in V$, the intersection $[x, y] \cap [y, z] \cap [x, z]$ consists of a unique vertex, which we denote by $m(x, y, z)$.

For every edge e in X , there exists a closest-point projection, called the *gate map* $g_e: V \rightarrow e(0)$. We also write $\{\alpha(e), \omega(e)\}$ for $e(0)$ and always

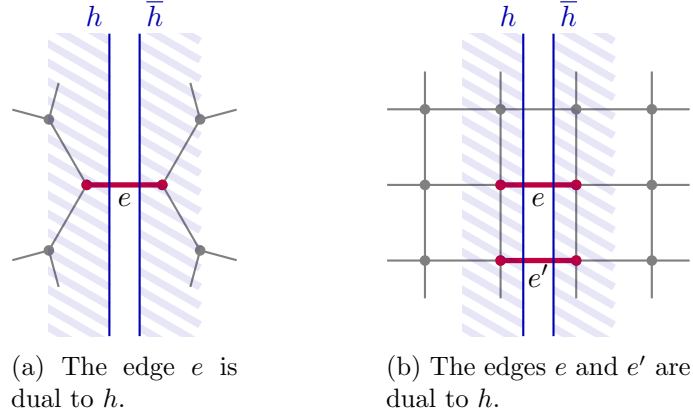

FIGURE 1. Halfspaces in a tree and a square grid.

make sure that the choice of labels for these two vertices does not matter. The vertex set then splits as $V = g_e^{-1}(\alpha(e)) \sqcup g_e^{-1}(\omega(e))$. Each of these sets is called a (*combinatorial*) *halfspace* (Figure 1). We write \mathcal{H} for the set of halfspaces in X . By definition, \mathcal{H} is equipped with a fixpoint-free involution $\mathcal{H} \rightarrow \mathcal{H}: h \mapsto \bar{h} := V \setminus h$. Another important property of halfspaces is that they are *convex*: Whenever $x, y \in h$, it follows that $[x, y] \subset h$. This will be clear from Lemma 3.2 below.

A *hyperplane* is a set $\{h, \bar{h}\}$, where $h \in \mathcal{H}$. If $h \in \mathcal{H}$ arises from g_e , we say that e is *dual* to the halfspace h and to the hyperplane $\{h, \bar{h}\}$. Every edge is dual to exactly one hyperplane, but different edges can be dual to the same hyperplane if they induce the same partition (Figure 1b).

Let $x, y \in V$. We say that a halfspace h *separates* y from x if $y \in h$ and $x \in \bar{h}$ (Figure 2a); this notion is *not* symmetric in y and x . Similarly, we may also speak of hyperplanes separating x and y . A combinatorial geodesic $\gamma = x_0 x_1 \cdots x_k$ is said to *cross into* a halfspace h at time i if h separates x_{i+1} from x_i (Figure 2b). In this case, we also say that γ *crosses* the hyperplane $\{h, \bar{h}\}$. The number of times h is crossed into by γ refers to the number of times i such that this holds. In fact, this number is always either 0 or 1.

Lemma 3.2 ([55][32, Remark 1.7]). *In the situation of Setup 3.1, let $x, y \in V$. Then the ℓ^1 -distance $D(x, y)$ is equal to the number of hyperplanes that separate x and y . More precisely, for every hyperplane H separating x and y , every geodesic from x to y crosses H exactly once.*

Because of Lemma 3.2, the set of halfspaces separating y from x will play an important role: We denote it by $[x, y]_{\mathcal{H}}$. Such sets are called *\mathcal{H} -intervals*. Notice that it is possible that $[x, y]_{\mathcal{H}} = [x', y']_{\mathcal{H}}$ for distinct pairs $(x, y), (x', y')$. The second part of Lemma 3.2 implies that $[x, y]_{\mathcal{H}} = [x, m]_{\mathcal{H}} \sqcup [m, y]_{\mathcal{H}}$ holds for every vertex $m \in [x, y]$ belonging to an oriented geodesic segment between x and y . This holds in particular when $m = m(x, y, z)$ for some third vertex z .

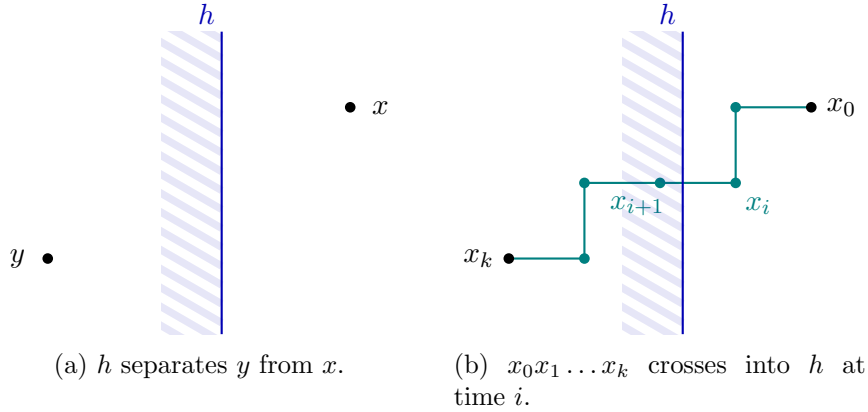

FIGURE 2. Separation by halfspaces.

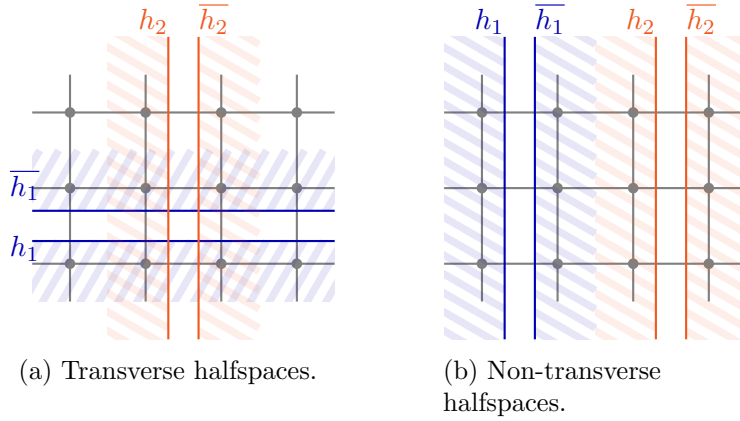

FIGURE 3. (Non-)transverse halfspaces in the square grid.

3.1.1. *Transversality.*

Definition 3.3 (transverse halfspaces). In the situation of Setup 3.1, two halfspaces h_1 and h_2 are *transverse* if each of the four intersections $h_1 \cap h_2$, $\overline{h_1} \cap h_2$, $h_1 \cap \overline{h_2}$, and $\overline{h_1} \cap \overline{h_2}$ is non-empty (Figure 3). We then write $h_1 \pitchfork h_2$ and also say that the pair h_1, h_2 is transverse.

Whenever two halfspaces are transverse, this is witnessed in a quadrangle:

Lemma 3.4. *In the situation of Setup 3.1, let h, k be halfspaces of X with $h \pitchfork k$. There is a quadrangle consisting of four edges e_H, f_H, e_K, f_K such that e_H, f_H are dual to the hyperplane $H := \{h, \overline{h}\}$ and such that e_K, f_K are dual to the hyperplane $K := \{k, \overline{k}\}$ (see Figure 4).*

Given a hyperplane $H = \{h, \overline{h}\}$, we denote by $\mathcal{N}(H)$ the *carrier* of H , namely the convex subcomplex of X spanned by all edges that cross H . We will use the following property of carriers:

Lemma 3.5. *Let H be a hyperplane and let $\mathcal{N}(H)$ be its carrier. Let γ be a geodesic contained in $\mathcal{N}(H)$. Then every hyperplane crossed by γ is either equal to H or transverse to H .*

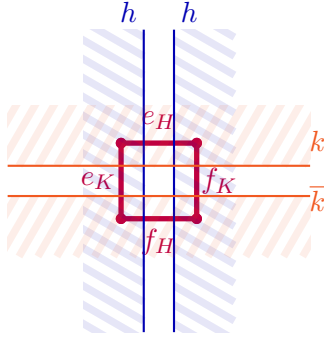

FIGURE 4. The quadrangle in Lemma 3.4

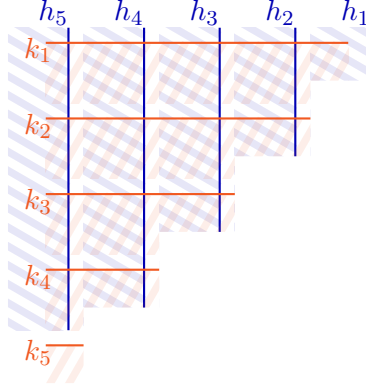

FIGURE 5. A staircase, schematically

In particular, if both endpoints of γ are contained in one side of H , then every hyperplane crossed by γ is transverse to H .

3.1.2. Finiteness conditions. We will be working with *finite-dimensional* CAT(0)-cube complexes, where the dimension of X is the highest dimension of a cube in X .

Moreover, we will impose the condition that the complexes have finite staircase length:

Definition 3.6 ([18, Definition 4.14]). Let X be a CAT(0) cube complex, let $\sigma \in \mathbb{N}$. A *length- σ staircase* in X is a pair $(h_1 \supset \cdots \supset h_\sigma, k_1 \supset \cdots \supset k_\sigma)$ of proper chains of halfspaces with the following properties (Figure 5):

- For all $i \in \{1, \dots, \sigma\}$ and all $j \in \{1, \dots, i-1\}$, we have $h_i \pitchfork k_j$.
- For all $i \in \{1, \dots, \sigma\}$, we have $h_i \supseteq k_i$.

The *staircase length* of X is the maximal length of a staircase in X (or ∞).

Remark 3.7. The numbering differs slightly from Fioravanti's convention [18], since this will make our arguments more transparent.

Example 3.8.

- Every tree has staircase length at most 1.
- Salvetti complexes have finite staircase length (Section 5).

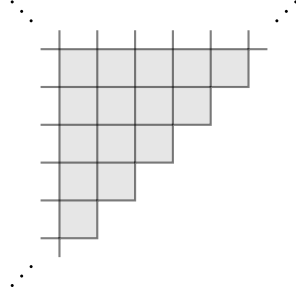

FIGURE 6. Beware of the infinite staircase!

- There exist finite-dimensional CAT(0) cube complexes with infinite staircase length, e.g., the infinite staircase in Figure 6.

3.2. Median quasimorphisms and median classes. Median quasimorphisms are a generalisation of counting quasimorphisms (Example 2.4). Instead of subwords in free groups, we count segments of crossed halfspaces for groups acting on CAT(0) cube complexes. We start with the definition of segments in terms of halfspaces [17].

Definition 3.9 (tightly nested, segment). In the situation of Setup 3.1, two halfspaces h_1 and h_2 are *tightly nested* if they are distinct, if $h_1 \supset h_2$, and if there is no other halfspace h such that $h_1 \supset h \supset h_2$ (Figure 7a).

An \mathcal{H} -segment of length $l \in \mathbb{N}$ is a sequence $(h_1 \supset \cdots \supset h_l)$ of tightly nested halfspaces (Figure 7b). The *reverse* of $s = (h_1 \supset \cdots \supset h_l)$ is $\bar{s} := (\bar{h}_l \supset \cdots \supset \bar{h}_1)$. We denote by $X_{\mathcal{H}}^{(l)}$ the set of all \mathcal{H} -segments of length l in X . Given $x, y \in V$, we write $[x, y]_{\mathcal{H}}^{(l)}$ for the set of all segments of length l that are contained in $[x, y]_{\mathcal{H}}$.

A vertex x is said to be in the *interior* of the segment $s = (h_1 \supset \cdots \supset h_l)$ if $x \in h_1 \cap \bar{h}_l$ (Figure 7b).

The action of Γ on X induces an action of Γ on $X_{\mathcal{H}}^{(l)}$; the orbit of $s \in X_{\mathcal{H}}^{(l)}$ is denoted by Γs , we call its elements *translates* of s .

In analogy with counting quasimorphisms, we introduce the associated counting functions, which will then lead to median quasimorphisms and classes.

Definition 3.10 (median quasimorphism). In the situation of Setup 3.1, let $l \in \mathbb{N}$, and let $s \in X_{\mathcal{H}}^{(l)}$. We define the *median quasimorphism* $f_s: V \times V \rightarrow \mathbb{R}$ for s for all $(x, y) \in V \times V$ to be the number of translates of s in $[x, y]_{\mathcal{H}}$ minus the number of translates of s in $[y, x]_{\mathcal{H}}$.

By construction, $f_s = f_{\gamma s}$ holds for all $\gamma \in \Gamma$. Moreover, the cochain f_s is Γ -invariant.

Remark 3.11. Note that whenever s and \bar{s} are in the same Γ -orbit, it follows from the definition that $f_s = 0$. If this is not the case, then the

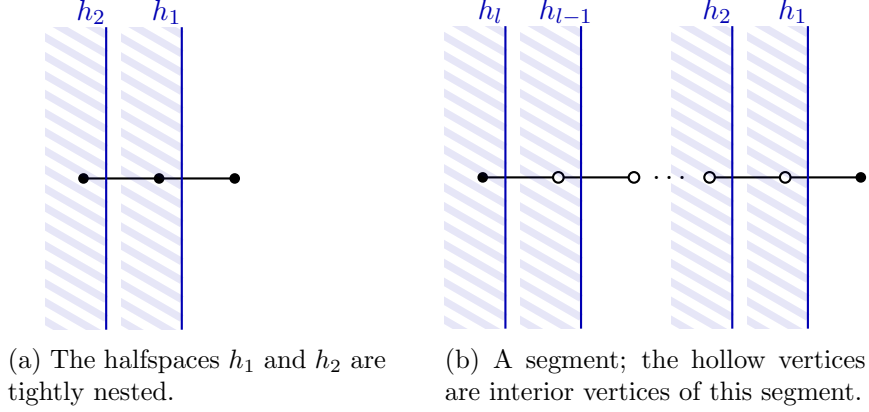

FIGURE 7. Tightly nested halfspaces and a segment.

following function $\varepsilon_s: X_{\mathcal{H}}^{(l)} \rightarrow \{-1, 0, 1\}$ is well-defined:

$$\varepsilon_s(t) = \begin{cases} 1, & \text{if } \Gamma t = \Gamma s, \\ -1, & \text{if } \Gamma t = \Gamma \bar{s}, \\ 0, & \text{otherwise} \end{cases}$$

Then, f_s is given by

$$(1) \quad f_s: V^2 \rightarrow \mathbb{R} \\ (x, y) \mapsto \sum_{t \in [x, y]_{\mathcal{H}}^{(l)}} \varepsilon_s(t).$$

We will use this formula for all of our computations.

It is not immediately clear that f_s indeed is a quasimorphism of $\Gamma \curvearrowright V$, i.e., that $\delta^1 f_s$ is bounded. Indeed, this is not true in full generality:

Example 3.12. For $n \geq 1$, let $X_n^- := [-1, 0]^n$, $X_n^+ := [0, 1]^n$, and let X_n be the wedge $X_n^- \vee X_n^+$, glued along the point $0 \in X_n^- \cap X_n^+$. Then X_n can be viewed as a CAT(0) cube complex, and together with the canonical inclusions $X_n \hookrightarrow X_{n+1}$, we obtain a directed system whose direct limit $X = X^+ \vee X^-$ is an infinite-dimensional CAT(0) cube complex (Figure 8). Moreover, X admits an action of the group $\Gamma := S_\infty \times S_\infty$, where S_∞ denotes the group of permutations of a countably infinite set with finite support. Here the factors act on X^- and X^+ respectively by permuting the coordinates; in particular, 0 is fixed by both factors. Let h^- be the halfspace $\{(0, *) \in X^-\} \cup X^+$, and h^+ the halfspace $\{(1, *) \in X^+\}$. Then $h^- \supset h^+$ are tightly nested, so they define a segment s . Let further $x_n^- := (-1, \dots, -1) \in X_n^- \subset X^-$ and $x_n^+ := (1, \dots, 1) \in X_n^+ \subset X^+$. Then $s \in [x_n^-, x_n^+]_{\mathcal{H}}^{(2)}$.

Since the action of Γ fixes 0 and preserves X^- and X^+ , the orbit Γs does not contain \bar{s} . Moreover, no translate of \bar{s} belongs to $[x_n^-, x_n^+]_{\mathcal{H}}^{(2)}$. On the other hand, $[x_n^-, x_n^+]_{\mathcal{H}}^{(2)}$ contains many translates of s : For instance, every element of $S_n \times S_n \leq \Gamma$ fixes x_n^- , 0 and x_n^+ , so it sends s to a segment

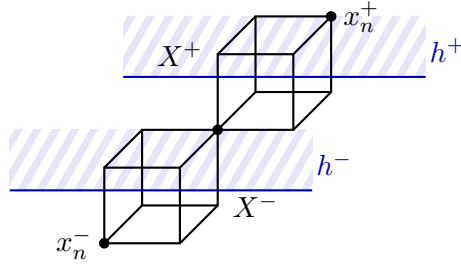

FIGURE 8. The construction of Example 3.12, schematically.

in $[x_n^-, x_n^+]_{\mathcal{H}}^{(2)}$. But h^- and h^+ are defined by conditions on the first coordinate only, so choosing elements in S_n that do not fix this coordinate, we obtain n^2 distinct translates of s that still lie in $[x_n^-, x_n^+]_{\mathcal{H}}^{(2)}$. Finally, since Γ preserves X^- and X^+ , there can be no translate of s or \bar{s} inside $[x_n^-, 0]_{\mathcal{H}}^{(2)}$ or $[0, x_n^+]_{\mathcal{H}}^{(2)}$.

The above discussion shows that

$$\begin{aligned} \delta^1 f_s(x_n^-, 0, x_n^+) &= f_s(0, x_n^+) - f_s(x_n^-, x_n^+) + f_s(x_n^-, 0) \\ &= 0 - |\Gamma s \cap [x_n^-, x_n^+]_{\mathcal{H}}^{(2)}| + 0 \leq -n^2. \end{aligned}$$

Varying n , we deduce that $\delta^1 f_s$ is unbounded.

Remark 3.13. The issue in Example 3.12 is not that Γ is infinitely generated. The same argument can be run with the direct square of any group of permutations of a countably infinite set that contains S_∞ . For instance, we could choose the Houghton group H_k [36], which is of type F_{k-1} .

The following examples shows that also for finite dimensional complexes, f_s need not be a quasimorphism. The obstruction here is given by infinite staircase length. (Note that the example Example 3.12 has finite staircase length, simply because there are no proper chains of halfspaces of length greater than 2.)

Example 3.14. Let X be the infinite staircase depicted in Figure 6. To describe points in X , we interpret it as being embedded in \mathbb{R}^2 , with vertices lying on \mathbb{Z}^2 and the “right-most points” given by the diagonal of \mathbb{Z}^2 , that is $V = \{(x, y) \in \mathbb{Z}^2 \mid x \leq y\}$. Let $\Gamma := \mathbb{Z}$ act on X by shifting along the diagonal of \mathbb{Z}^2 , i.e., $\gamma \cdot (x, y) = (x + \gamma, y + \gamma)$ for $\gamma \in \mathbb{Z}$, $(x, y) \in V$.

We define $h^x = \{(x, y) \in V \mid y > 0\}$ and $h^y = \{(x, y) \in V \mid x > 0\}$ to be the halfspaces that are dual to the edges $((0, 0), (0, 1))$ and $((0, 1), (1, 1))$, respectively, and point to the “upper right”. These halfspaces are tightly nested $h^x \supset h^y$, so define a segment s . As the action of Γ preserves the orientation of $X \subset \mathbb{Z}^2$, the orbit Γs does not contain \bar{s} . We define a sequence of triples in V that witnesses that $\delta^1 f_s$ is unbounded: For $n \in \mathbb{N}$, let $x_n = (0, 0)$, $y_n = (0, n+1)$, $z_n = (n+1, n+1)$. Clearly, $\gamma h^x = \{(x, y) \in V \mid y > \gamma\}$ contains y_n if and only if it contains z_n and $\gamma h^y = \{(x, y) \in V \mid x > \gamma\}$ contains x_n if and only if it contains y_n . The same is true for \bar{h}^x and \bar{h}^y . This implies that $f_s(y_n, z_n) = 0 = f_s(x_n, y_n)$. Similarly, it is not hard to see

that $[x_n, z_n]_{\mathcal{H}}^{(2)}$ contains n translates of s and no translate of \bar{s} . Hence, we get

$$\begin{aligned}\delta^1 f_s(x_n, y_n, z_n) &= f_s(y_n, z_n) - f_s(x_n, z_n) + f_s(x_n, y_n) \\ &= 0 - n + 0.\end{aligned}$$

Varying n , we deduce that $\delta^1 f_s$ is unbounded.

A way to avoid both pathological examples above is to add the hypotheses of finite-dimensionality and finite staircase length. It will turn out that imposing these hypotheses is actually sufficient for showing that f_s is a quasimorphism. As a preparation, we show the following estimate, which will also be crucial in the proof of Theorem 3.23:

Lemma 3.15. *Let X be a CAT(0) cube complex of finite dimension d and with finite staircase length σ . Then for all $x, y \in V$ and all $m \in [x, y]$, the number of segments in $[x, y]_{\mathcal{H}}^{(l)}$ that contain m in their interior is at most $(l-1)\sigma d^l$.*

Proof. We start by showing the lemma in the case $l = 2$. The statement gives the bound σd^2 on the number of pairs of tightly nested halfspaces $h \supset k$ such that $x \in \bar{h}$, $m \in h \cap \bar{k}$, and $y \in k$.

Let B be the set of all such pairs, and *assume* by contradiction that $|B| > \sigma d^2$. The set of all halfspaces separating x from y decomposes into a disjoint union of d (possibly empty) chains [6, Lemma 1.16]. Hence, each pair in B belongs to one of d^2 types of chain-memberships of the two components. By the pigeonhole principle, there exist $\sigma + 1$ distinct pairs in B such that the first components form a chain and simultaneously also the second components form a chain. We number the pairs $(h_1, k_1), \dots, (h_{\sigma+1}, k_{\sigma+1})$ in such a way that $h_1 \supset h_2 \supset \dots \supset h_{\sigma} \supset h_{\sigma+1}$.

First, we claim that $k_i \supset k_{i+1}$, for all $i \in \{1, \dots, \sigma\}$. As the second components form a chain, we have $k_i \supset k_{i+1}$ or $k_{i+1} \supset k_i$. However, in the latter case, we would obtain the chain $h_i \supset h_{i+1} \supset k_{i+1} \supset k_i$. Because (h_i, k_i) is a tightly nested pair and $h_{i+1} \neq k_{i+1}$, this would imply $h_i = h_{i+1}$ and $k_{i+1} = k_i$, which would contradict that the pairs (h_i, k_i) and (h_{i+1}, k_{i+1}) are different. Therefore, $k_i \supset k_{i+1}$.

We obtained the inclusions $h_1 \supset \dots \supset h_{\sigma+1}$ and $k_1 \supset \dots \supset k_{\sigma+1}$. Next we show that they are all proper: *Assume* for a contradiction that there is an $i \in \{1, \dots, \sigma\}$ with $h_i = h_{i+1}$ (the case $k_i = k_{i+1}$ is symmetric). Then $k_i \neq k_{i+1}$, since the pairs (h_i, k_i) and (h_{i+1}, k_{i+1}) are different. Thus, $h_{i+1} = h_i \supsetneq k_i \supsetneq k_{i+1}$, which contradicts that $h_{i+1} \supset k_{i+1}$ are tightly nested.

Finally, we show that $h_i \cap k_j$ for all $i \in \{1, \dots, \sigma + 1\}$ and all $j \in \{1, \dots, i - 1\}$. This will show that $h_1 \supset \dots \supset h_{\sigma+1}$ and $k_1 \supset \dots \supset k_{\sigma+1}$ form a staircase of length $\sigma + 1$, contradicting the hypothesis that X has staircase length σ . So, let $i \in \{1, \dots, \sigma + 1\}$ and $j \in \{1, \dots, i - 1\}$. Then $\bar{h}_i \cap \bar{k}_j \neq \emptyset$ (because of x) and $h_i \cap \bar{k}_j \neq \emptyset$ (because of m) as well as $h_i \cap k_j \neq \emptyset$ (because of y). It remains to show that $\bar{h}_i \cap k_j$ is non-empty. If $\bar{h}_i \cap k_j$ were empty, then we would have $h_i \supset k_j$, and thus $h_j \supsetneq h_i \supsetneq k_j$, which contradicts that $h_j \supsetneq k_j$ are tightly nested. Hence, $\bar{h}_i \cap k_j \neq \emptyset$. This concludes the proof in the case $l = 2$.

Now we prove the general case. Consider a segment $t = (h_1 \supset \cdots \supset h_l) \in [x, y]_{\mathcal{H}}^{(l)}$. Since $m \in [x, y]$, there exists $i \in \{1, \dots, l-1\}$ such that $m \in h_i \cap \overline{h_{i+1}}$, and the previous case gives at most σd^2 options for the pair (h_i, h_{i+1}) . We claim that in addition to the $l-1$ options for i , there are at most d options for each of the remaining $(l-2)$ halfspaces. Indeed, assume that we have already chosen h_{i+2}, \dots, h_j and we need to choose h_{j+1} . The latter needs to lie in $[\overline{h_j}, y]_{\mathcal{H}}$, that is, the set of halfspaces containing y and contained in h_j . Moreover, it needs to be a maximal element of this set, because (h_j, h_{j+1}) must be tightly nested. But maximal elements are pairwise transverse, and X is d -dimensional, so there are at most d options for h_{j+1} . The same argument, assuming that h_j, \dots, h_{i-1} have been chosen, gives at most d options for h_{j-1} , and concludes the proof. \square

Proposition 3.16 (defect estimate). *In the situation of Setup 3.1, let X be a CAT(0)-cube complex of dimension d and finite staircase length σ . Let $l \in \mathbb{N}$ and let $s \in X_{\mathcal{H}}^{(l)}$ be a segment. Then $\delta^1 f_s: V^3 \rightarrow \mathbb{R}$ is bounded. More precisely,*

$$\|\delta^1 f_s\|_{\infty} \leq 3(l-1)\sigma d^l.$$

Proof. The statement is obvious if $f_s = 0$, so we may assume that $\Gamma s \neq \Gamma \bar{s}$ and use Equation (1) from Remark 3.11. As a first step, we consider the following situation: Let $x, y \in V$, and let $m \in [x, y]$. Then $[x, y]_{\mathcal{H}} = [x, m]_{\mathcal{H}} \sqcup [m, y]_{\mathcal{H}}$, and thus

$$\begin{aligned} f_s(x, y) &= \sum_{t \in [x, y]_{\mathcal{H}}^{(l)}} \varepsilon_s(t) \\ &= \sum_{t \in [x, m]_{\mathcal{H}}^{(l)}} \varepsilon_s(t) + \sum_{t \in [m, y]_{\mathcal{H}}^{(l)}} \varepsilon_s(t) + \sum_{t \in [x, y]_{\mathcal{H}}^{(l)} \setminus [x, m]_{\mathcal{H}}^{(l)} \cup [m, y]_{\mathcal{H}}^{(l)}} \varepsilon_s(t) \\ &= f_s(x, m) + f_s(m, y) + \sum_{t \in [x, y]_{\mathcal{H}}^{(l)} \setminus [x, m]_{\mathcal{H}}^{(l)} \cup [m, y]_{\mathcal{H}}^{(l)}} \varepsilon_s(t). \end{aligned}$$

A segment t appears in the last sum only if m belongs to the interior of t (Figure 9). Therefore, Lemma 3.15 shows that there are at most $(l-1)\sigma d^l$ terms in this sum.

For the general case, let $x, y, z \in V$ and $m := m(x, y, z)$. Then the previous estimate shows that

$$\begin{aligned} |\delta^1 f_s(x, y, z)| &= |f_s(y, z) - f_s(x, z) + f_s(x, y)| \\ &\leq 3 \cdot (l-1)\sigma d^l + A, \end{aligned}$$

where the term

$$A := |(f_s(y, m) + f_s(m, z)) - (f_s(x, m) + f_s(m, z)) + (f_s(x, m) + f_s(m, y))|$$

vanishes since f_s is antisymmetric. \square

It is instructive to consider the case of a (big) Brooks quasimorphism H_w . Then $d = \sigma = 1$, $l = |w|$ and the ℓ^∞ -norm of the coboundary coincides with the defect. Hence, the bound $3(|w| - 1)$ from Proposition 3.16 matches the bound from Section 2.3.

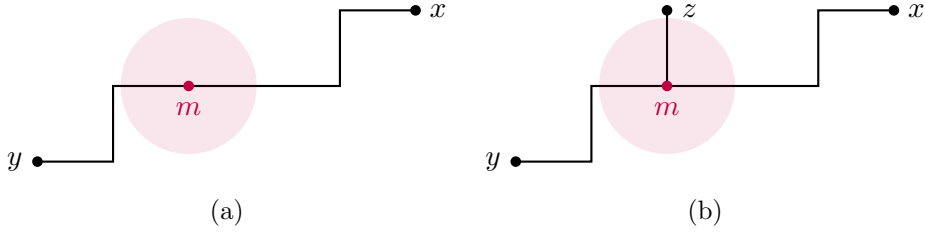

FIGURE 9. The critical areas in the two cases of the proof of Proposition 3.16.

Definition 3.17 (median class). In the situation of Proposition 3.16, by Remark 2.9), we obtain a bounded cohomology class $[\delta^1 f_s] \in H_{\Gamma, b}^2(X; \mathbb{R})$. We call this the *median class* of s .

Remark 3.18. Related bounded cohomology classes appeared in the work of Chatterji, Fernós, and Iozzi [15]: Note that in that case too, the boundedness of the relevant classes is achieved by working in the finite-dimensional setting and additional restrictions on the segments. Similarly to these restrictions on the segments, we could also replace the hypothesis on finite staircase length by imposing more refined constraints on the segments than consecutive halfspaces being “tightly nested”.

Also, non-overlapping versions of the quasimorphisms by Chatterji, Fernós, and Iozzi were considered [17, 19]; in that situation, the finite-dimensionality hypothesis is not needed, and the defect is uniformly bounded.

3.3. Cup products of median classes with non-transverse classes.

In general, cup products of median classes can be non-trivial:

Example 3.19. Let F be a non-abelian free group and let T be a Cayley tree of F . We consider the product action $F \times F \curvearrowright X := T \times T$ of the translation action $F \curvearrowright T$. Then X carries a canonical structure of a CAT(0) cube complex.

Let $\varphi \in H_b^2(F; \mathbb{R}) \setminus \{0\}$. For the canonical projections $p_1, p_2: F \times F \rightarrow F$, we then obtain [43, Proposition 3.3]

$$H_b^2(p_1; \mathbb{R})(\varphi) \cup H_b^2(p_2; \mathbb{R})(\varphi) \neq 0$$

in $H_b^4(F \times F; \mathbb{R}) \cong H_{F \times F, b}^4(X; \mathbb{R})$. Moreover, if φ is induced by the Brooks quasimorphism of $w \in F$, then $H_b^2(p_i; \mathbb{R})(\varphi)$ are the classes given by the median quasimorphisms of the segments induced by w on X via the two factors T in X .

More generally, let $X := T_1 \times T_2$ be a product of two trees. Every edge e in X is of the form $e_1 \times x_2$, where e_1 is an edge in T_1 and x_2 is a vertex in T_2 , or the other way around. If h_1, \bar{h}_1 are the halfspaces dual to e_1 in T_1 , then $h_1 \times T_2$ and $\bar{h}_1 \times T_2$ are the halfspaces dual to e in X . Therefore an \mathcal{H} -segment s_i in T_i defines a segment \hat{s}_i in X .

Now suppose that Γ acts on each T_i , and equip X with the product action of $\Gamma \times \Gamma$. Then $[\delta^1 f_{\hat{s}_i}] \in H_{\Gamma, b}^2(X; \mathbb{R})$ is the pullback of $[\delta^1 f_{s_i}] \in H_{\Gamma, b}^2(T_i; \mathbb{R})$ under the projection $X \rightarrow T_i$. The same arguments as for the free group

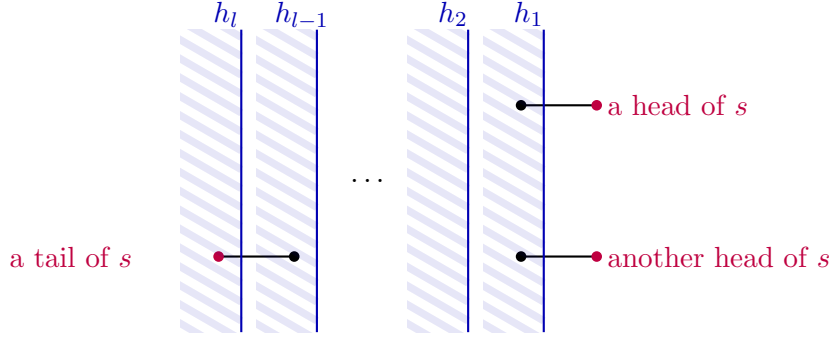

FIGURE 10. Heads and tails of segments.

case show: If both $[\delta^1 f_{s_i}]$ are non-trivial, then

$$[\delta^1 f_{\widehat{s}_1}] \cup [\delta^1 f_{\widehat{s}_2}] \neq 0 \in H_{\Gamma \times \Gamma, b}^4(X; \mathbb{R}),$$

so the cup product is non-trivial.

We will prove the vanishing of cup products under an additional assumption that avoids the above behaviour.

Definition 3.20 (heads/tails). In the situation of Setup 3.1, let $s = (h_1 \supset \dots \supset h_l) \in X_{\mathcal{H}}^{(l)}$. We say that $\alpha \in V$ is a *head* of s if $\alpha \in \overline{h_1}$ and there exists an edge dual to h_1 that has α as one of its endpoints (Figure 10). We say that $\omega \in V$ is a *tail* of s if $\omega \in h_l$ and there exists an edge dual to h_l that has ω as one of its endpoints.

We let $\alpha(s)$ denote the set of heads of s and we let $\omega(s)$ denote the set of tails of s . By definition, $\alpha(\overline{s}) = \omega(s)$ and $\omega(\overline{s}) = \alpha(s)$.

Definition 3.21 (non-transverse). In the situation of Setup 3.1, let $s \in X_{\mathcal{H}}^{(l)}$ and let $\kappa \in C_{\Gamma, b}^n(X, \mathbb{R})$. We say that κ and s are *non-transverse* if for all $x_1, \dots, x_n \in V$, the value of $\kappa(\alpha, x_1, \dots, x_n)$ is constant over all $\alpha \in \alpha(s)$, and the value of $\kappa(\omega, x_1, \dots, x_n)$ is constant over all $\omega \in \omega(s)$. Given a set $S \subset X_{\mathcal{H}}^{(l)}$, we say that κ and S are *non-transverse* if κ and s are non-transverse for all $s \in S$.

We define similarly non-transversality with respect to equivariant bounded cohomology classes, where a class has the property if it admits a representative that does.

By symmetry of the definitions of heads and tails, κ is transverse to Γs if and only if it is transverse to $\Gamma \overline{s}$.

Remark 3.22. In the square grid (with the translation action by \mathbb{Z}^2), we consider two ‘‘orthogonal’’ segments \widehat{s}_1 and \widehat{s}_2 as in Figure 11. Then, the cochain $\delta^1 f_{\widehat{s}_2}$ and the orbit $\mathbb{Z}^2 \widehat{s}_1$ are not non-transverse.

Similarly, a straightforward computation shows that in Example 3.19, the cochain $\delta^1 f_{\widehat{s}_2}$ and the orbit $\Gamma \widehat{s}_1$ are not non-transverse.

The main point of Definition 3.21 is that it allows to define the auxiliary map $\tilde{\kappa}$ in the proof below, similarly to the auxiliary maps used in previous work on cup products of quasimorphisms.

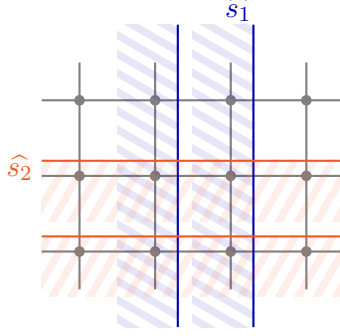

FIGURE 11. Not non-transversality in the square grid (Remark 3.22).

Theorem 3.23. *Let $\Gamma \curvearrowright X$ be an action of a group Γ on a finite-dimensional CAT(0) cube complex X with finite staircase length. Let $l \in \mathbb{N}$, let $s \in X_{\mathcal{H}}^{(l)}$, and let $\zeta \in \mathbb{H}_{\Gamma, b}^n(X; \mathbb{R})$ be non-transverse to Γs . Then*

$$[\delta^1 f_s] \cup \zeta = 0 \in \mathbb{H}_{\Gamma, b}^{n+2}(X; \mathbb{R}).$$

Proof. The statement is obvious if $f_s = 0$, so we may assume that $\Gamma s \neq \Gamma \bar{s}$ and use Equation (1) from Remark 3.11. Let κ be a cocycle representing ζ that is non-transverse to Γs . As in the proofs of the corresponding results for free or surface groups [34, 1, 46], we provide an explicit construction of a bounded cochain $\beta \in C_{\Gamma, b}^{n+1}(X; \mathbb{R})$ with

$$\delta^{n+1} \beta = (\delta^1 f_s) \cup \kappa.$$

More specifically, it suffices to find a cochain $\eta \in C_{\Gamma, b}^n(X; \mathbb{R})$ such that

$$\beta := f_s \cup \kappa + \delta^n \eta$$

is bounded. Indeed:

$$\delta^{n+1}(f_s \cup \kappa + \delta^n \eta) = \delta^1(f_s) \cup \kappa - f_s \cup \delta^n(\kappa) + \delta^{n+1}(\delta^n \eta) = \delta^1 f_s \cup \kappa.$$

Construction of η . For $t \in X_{\mathcal{H}}^{(l)}$ and $x_1, \dots, x_n \in V$, we define

$$\tilde{\kappa}(t, x_1, \dots, x_n) := \frac{1}{2} \cdot \varepsilon_s(t) \cdot (\kappa(\alpha, x_1, \dots, x_n) + \kappa(\omega, x_1, \dots, x_n)),$$

where $\alpha \in \alpha(t)$ and $\omega \in \omega(t)$. This is well-defined, i.e., independent of the choices of α and ω : If $t \in \Gamma s \cup \Gamma \bar{s}$, then we apply that κ and t are non-transverse (recall that κ and $\Gamma \bar{s}$ are also non-transverse). Otherwise, by definition $\varepsilon_s(t) = 0$ and so the whole term is 0.

By construction, $\tilde{\kappa}(t, x_1, \dots, x_n) = 0$ if $t \notin \Gamma s \cup \Gamma \bar{s}$; moreover, $\|\tilde{\kappa}\|_{\infty} \leq \|\kappa\|_{\infty}$, and $\tilde{\kappa}$ satisfies the identity

$$(2) \quad \tilde{\kappa}(t, x_1, \dots, x_n) = -\tilde{\kappa}(\bar{t}, x_1, \dots, x_n).$$

We now define $\eta: V^{n+1} \rightarrow \mathbb{R}$ via

$$\eta(x_0, x_1, \dots, x_n) := \sum_{t \in [x_0, x_1]_{\mathcal{H}}^{(l)}} \tilde{\kappa}(t, x_1, \dots, x_n).$$

Boundedness of β . Let $x_0, \dots, x_{n+1} \in V$. By definition, we have

$$\begin{aligned} \beta(x_0, \dots, x_{n+1}) &= f_s(x_0, x_1) \cdot \kappa(x_1, \dots, x_{n+1}) \\ &\quad + \eta(x_1, \dots, x_{n+1}) - \eta(x_0, x_2, \dots, x_{n+1}) \\ &\quad + \sum_{j=2}^{n+1} (-1)^j \cdot \eta(x_0, x_1, \dots, \hat{x}_j, \dots, x_{n+1}). \end{aligned}$$

Entering the definitions of the counting map f_s (Remark 3.11) and η , we get

$$\begin{aligned} \beta(x_0, \dots, x_{n+1}) &= \sum_{t \in [x_0, x_1]_{\mathcal{H}}^{(l)}} \varepsilon_s(t) \cdot \kappa(x_1, \dots, x_{n+1}) \\ &\quad + \sum_{t \in [x_1, x_2]_{\mathcal{H}}^{(l)}} \tilde{\kappa}(t, x_2, \dots, x_{n+1}) - \sum_{t \in [x_0, x_2]_{\mathcal{H}}^{(l)}} \tilde{\kappa}(t, x_2, \dots, x_{n+1}) \\ &\quad + \sum_{j=2}^{n+1} (-1)^j \sum_{t \in [x_0, x_1]_{\mathcal{H}}^{(l)}} \tilde{\kappa}(t, x_1, \dots, \hat{x}_j, \dots, x_{n+1}). \end{aligned}$$

The cochain κ is a cocycle. Therefore, for all $y \in V$, we have

$$\begin{aligned} 0 &= \delta^n \kappa(y, x_1, \dots, x_{n+1}) \\ &= \kappa(x_1, \dots, x_{n+1}) - \kappa(y, x_2, \dots, x_{n+1}) \\ &\quad + \sum_{j=2}^{n+1} (-1)^j \cdot \kappa(y, x_1, \dots, \hat{x}_j, \dots, x_{n+1}). \end{aligned}$$

Using this once for $\alpha \in \alpha(t)$ and once for $\omega \in \omega(t)$, we see that

$$\begin{aligned} &2 \cdot \sum_{t \in [x_0, x_1]_{\mathcal{H}}^{(l)}} \varepsilon_s(t) \cdot \kappa(x_1, \dots, x_{n+1}) \\ &= \sum_{t \in [x_0, x_1]_{\mathcal{H}}^{(l)}} \varepsilon_s(t) \cdot \left(\kappa(\alpha, x_2, \dots, x_{n+1}) - \sum_{j=2}^{n+1} (-1)^j \kappa(\alpha, x_1, \dots, \hat{x}_j, \dots, x_{n+1}) \right. \\ &\quad \left. + \kappa(\omega, x_2, \dots, x_{n+1}) - \sum_{j=2}^{n+1} (-1)^j \kappa(\omega, x_1, \dots, \hat{x}_j, \dots, x_{n+1}) \right) \\ &= 2 \cdot \sum_{t \in [x_0, x_1]_{\mathcal{H}}^{(l)}} \left(\tilde{\kappa}(t, x_2, \dots, x_{n+1}) - \sum_{j=2}^{n+1} (-1)^j \tilde{\kappa}(t, x_1, \dots, \hat{x}_j, \dots, x_{n+1}) \right). \end{aligned}$$

This allows us to simplify the above to

$$\begin{aligned} \beta(x_0, \dots, x_{n+1}) &= \sum_{t \in [x_0, x_1]_{\mathcal{H}}^{(l)}} \tilde{\kappa}(t, x_2, \dots, x_{n+1}) \\ &\quad + \sum_{t \in [x_1, x_2]_{\mathcal{H}}^{(l)}} \tilde{\kappa}(t, x_2, \dots, x_{n+1}) - \sum_{t \in [x_0, x_2]_{\mathcal{H}}^{(l)}} \tilde{\kappa}(t, x_2, \dots, x_{n+1}). \end{aligned}$$

Now let m denote the median of x_0, x_1, x_2 . For all $i \neq j$, the union $[x_i, m]_{\mathcal{H}}^{(l)} \cup [m, x_j]_{\mathcal{H}}^{(l)}$ is contained in $[x_i, x_j]_{\mathcal{H}}^{(l)}$ and the only segments in $[x_i, x_j]_{\mathcal{H}}^{(l)}$ that are not contained in this union are those that contain m in their interior. There are at most $(l-1)\sigma d^l$ of those, by Lemma 3.15, where $d = \dim(X)$ and σ is the staircase length of X . Hence, we can rewrite

$$\begin{aligned} \sum_{t \in [x_i, x_j]_{\mathcal{H}}^{(l)}} \tilde{\kappa}(t, x_2, \dots, x_{n+1}) &= \sum_{t \in [x_i, m]_{\mathcal{H}}^{(l)}} \tilde{\kappa}(t, x_2, \dots, x_{n+1}) \\ &+ \sum_{t \in [m, x_j]_{\mathcal{H}}^{(l)}} \tilde{\kappa}(t, x_2, \dots, x_{n+1}) \\ &+ \sum_{t \in [x_i, x_j]_{\mathcal{H}}^{(l)} \setminus [x_i, m]_{\mathcal{H}}^{(l)} \cup [m, x_j]_{\mathcal{H}}^{(l)}} \tilde{\kappa}(t, x_2, \dots, x_{n+1}) \end{aligned}$$

and the last sum is bounded by $(l-1)\sigma d^l \cdot \|\tilde{\kappa}\|_{\infty} \leq (l-1)\sigma d^l \cdot \|\kappa\|_{\infty}$.

It follows that up to a uniformly (in x_0, \dots, x_{n+1}) bounded error, we have

$$\begin{aligned} \beta(x_0, \dots, x_{n+1}) &= \sum_{t \in [x_0, m]_{\mathcal{H}}^{(l)}} \tilde{\kappa}(t, x_2, \dots, x_{n+1}) + \sum_{t \in [m, x_1]_{\mathcal{H}}^{(l)}} \tilde{\kappa}(t, x_2, \dots, x_{n+1}) \\ &+ \sum_{t \in [x_1, m]_{\mathcal{H}}^{(l)}} \tilde{\kappa}(t, x_2, \dots, x_{n+1}) + \sum_{t \in [m, x_2]_{\mathcal{H}}^{(l)}} \tilde{\kappa}(t, x_2, \dots, x_{n+1}) \\ &- \sum_{t \in [x_0, m]_{\mathcal{H}}^{(l)}} \tilde{\kappa}(t, x_2, \dots, x_{n+1}) - \sum_{t \in [m, x_2]_{\mathcal{H}}^{(l)}} \tilde{\kappa}(t, x_2, \dots, x_{n+1}). \end{aligned}$$

This is 0 because by Equation (2), we have

$$\sum_{t \in [m, x_1]_{\mathcal{H}}^{(l)}} \tilde{\kappa}(t, x_2, \dots, x_{n+1}) = - \sum_{t \in [x_1, m]_{\mathcal{H}}^{(l)}} \tilde{\kappa}(t, x_2, \dots, x_{n+1}).$$

In fact, this is the only place in the argument that uses the symmetry of Equation (2). \square

By applying the orbit map (Subsection 2.2), we obtain a vanishing result in bounded cohomology of groups:

Corollary 3.24. *Let $\Gamma \curvearrowright X$ be an action of a group Γ on a finite-dimensional CAT(0) cube complex X with finite staircase length. Let $l \in \mathbb{N}$, let $s \in X_{\mathcal{H}}^{(l)}$, let $x \in V$ and let $\zeta \in H_{\Gamma, b}^n(X; \mathbb{R})$ be non-transverse to Γs . Then*

$$[\delta^1 \widehat{f_{s,x}}] \cup o_x^n(\zeta) = 0 \in H_b^{n+2}(\Gamma; \mathbb{R}).$$

Proof. This follows directly from Theorem 3.23 (see Remark 2.10). \square

3.4. Cup products of two median classes. As a special case, we consider the cup product of two median classes $[\delta^1 f_r]$ and $[\delta^1 f_s]$.

The non-transversality hypothesis in Theorem 3.23 can be easily checked in this case and is closely related to the notion of (non-)transversality for halfspaces from Definition 3.3.

Theorem 3.25. *Let $\Gamma \curvearrowright X$ be an action of a group Γ on a finite-dimensional CAT(0) cube complex X with finite staircase length. Let $s = (h_1 \supset \dots \supset h_l)$*

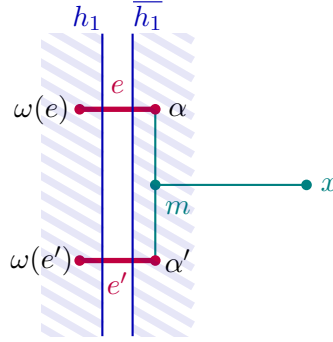

FIGURE 12. The situation in the proof of Theorem 3.25.

and $r = (k_1 \supset \cdots \supset k_p)$ be \mathcal{H} -segments in X . Suppose that each of the four pairs $\Gamma h_1, \Gamma k_1$; $\Gamma h_1, \Gamma k_p$; $\Gamma \bar{h}_1, \Gamma k_1$; $\Gamma \bar{h}_1, \Gamma k_p$ is non-transverse. Then $\delta^1 f_r$ and Γs are non-transverse. In particular, by Theorem 3.23:

$$[\delta^1 f_s] \cup [\delta^1 f_r] = 0 \in H_{\Gamma, b}^4(X; \mathbb{R}).$$

Proof. Again we may assume that $\Gamma r \neq \Gamma \bar{r}$ and use Equation (1) from Remark 3.11. We show that $\delta^1 f_r(\alpha, x_1, x_2)$ is independent of $\alpha \in \alpha(t)$ whenever $t \in \Gamma s$, under the assumption that the two pairs $\Gamma h_1, \Gamma k_1$ and $\Gamma h_1, \Gamma k_p$ are non-transverse (the proof for $\omega \in \omega(t)$ is analogous, using that the two remaining pairs are non-transverse). For this, it is enough to show that $f_r(\alpha, x)$ is independent of $\alpha \in \alpha(t)$ whenever $t \in \Gamma s$. Since $\alpha(\gamma s) = \gamma \alpha(s)$ is Γ -invariant, it suffices to show the statement for $t = s$.

So let $\alpha \in \alpha(s)$. By definition, there exists an edge e dual to \bar{h}_1 that has α as one of its endpoints and $\alpha \in \bar{h}_1$. Let $\alpha' \in \alpha(s)$ and let e' be the corresponding edge. Let $m := m(\alpha, \alpha', x)$. Thus, $m \in \bar{h}_1$, since $m \in [\alpha, \alpha']$ and \bar{h}_1 is convex. The notation is illustrated in Figure 12.

Note that α and α' belong to $\mathcal{N}(\{h_1, \bar{h}_1\}) \cap \bar{h}_1$, so Lemma 3.5 implies that $[\alpha, \alpha']_{\mathcal{H}}$ intersects each of the orbits $\Gamma k_1, \Gamma \bar{k}_1, \Gamma k_p$, and $\Gamma \bar{k}_p$ only trivially. We obtain that the same also holds for $[\alpha, m]_{\mathcal{H}} \subset [\alpha, \alpha']_{\mathcal{H}}$. This implies that every occurrence of γr or $\gamma \bar{r}$ in $[\alpha, x]_{\mathcal{H}}$ cannot intersect $[\alpha, m]_{\mathcal{H}}$, and thus $[\alpha, x]_{\mathcal{H}}^{(p)} \cap \Gamma r = [m, x]_{\mathcal{H}}^{(p)} \cap \Gamma r$. By symmetry, the analogous statements hold upon switching α and α' . Thus:

$$f_r(\alpha, x) = \sum_{t \in [\alpha, x]_{\mathcal{H}}^{(p)}} \varepsilon_r(t) = \sum_{t \in [m, x]_{\mathcal{H}}^{(p)}} \varepsilon_r(t) = \sum_{t \in [\alpha', x]_{\mathcal{H}}^{(p)}} \varepsilon_r(t) = f_r(\alpha', x). \quad \square$$

4. TREES

We specialise the results of Section 3 to the case of actions on trees. Fix a tree $T = (V, E)$ and an action of a group Γ on T . Seeing T as a CAT(0) cube complex, halfspaces in T correspond to oriented edges, and hyperplanes to unoriented edges. Therefore \mathcal{H} -segments and oriented geodesic segments are in one-to-one correspondence, with the same value of length. The definition of the median quasimorphism then takes the following familiar form:

Definition 4.1 (median quasimorphism, tree case). In the situation above, let s be an oriented geodesic segment in T . We define the *median quasimorphism* $f_s: V \times V \rightarrow \mathbb{R}$ for s for all $(x, y) \in V \times V$ to be the number of translates of s in $[x, y]$ minus the number of translates of s in $[y, x]$.

Once again, if $\Gamma s = \Gamma \bar{s}$ then $f_s = 0$, and otherwise it can be computed by a formula as in Remark 3.11 [38, Section 3.1].

If $x \in V$, the quasimorphism $f_{s,x}$ on Γ associated with the quasimorphism f_s of $\Gamma \curvearrowright T$ via the orbit map of the base vertex x is the median quasimorphism as considered by Monod and Shalom [51]. For many interesting actions, such median quasimorphisms produce uncountably many linearly independent quasimorphisms [38]¹.

Example 4.2 (Brooks quasimorphisms as median quasimorphisms). Let F be a non-abelian free group with a fixed basis, let T be the corresponding Cayley tree. A reduced word $w \in F$ defines a segment s in T of length $|w|$. Then $f_{s,1}$, the pullback of the median quasimorphism f_s under the orbit map at 1, coincides with the (big) Brooks quasimorphism H_w on F .

Moreover, given a segment $s = [x, y]$, its head and tail (Definition 3.20) are uniquely defined as $x = \alpha(s)$, $y = \omega(s)$. In particular, for every segment s and every $\kappa \in C_{\Gamma,b}^n(T, \mathbb{R})$, we trivially have that κ and s are non-transverse. Moreover, trees are finite-dimensional and have finite staircase length. So Theorem 3.23 holds without any additional assumptions:

Theorem 4.3. *Let $\Gamma \curvearrowright T$ be an action of a group Γ on a tree T . Let s be an oriented geodesic segment in T , and let f_s be the corresponding median quasimorphism for $\Gamma \curvearrowright T$. Then, for all $n \geq 1$ and all $\zeta \in H_{\Gamma,b}^n(T; \mathbb{R})$, we have*

$$[\delta^1 f_s] \cup \zeta = 0 \in H_{\Gamma,b}^{n+2}(T; \mathbb{R}).$$

Similarly, Corollary 3.24 implies:

Corollary 4.4. *Let $\Gamma \curvearrowright T$ be an action of a group Γ on a tree T . Let x be a vertex, let s be an oriented geodesic segment, and let $f_{s,x}$ be the corresponding median quasimorphism of Γ . Then for every $n \geq 1$ and every class $\zeta \in o_x^n(H_{\Gamma,b}^n(T; \mathbb{R})) \subset H_b^n(\Gamma; \mathbb{R})$, we have*

$$[\delta^1 f_{s,x}] \cup \zeta = 0.$$

In particular, this holds in the following cases:

- (1) When $\zeta = [\delta^1 \widehat{f_{r,w}}]$ for some other segment r and vertex w in T ;
- (2) For every $\zeta \in H_b^n(\Gamma; \mathbb{R})$ if all vertex stabilizers are amenable.

Proof. The last statement is the only one that is specific to trees, and it follows by applying Theorem 2.2. \square

Remark 4.5. Let Γ be a group acting on a tree T with amenable vertex stabilizers. Then all edge stabilizers are also amenable. Therefore up to taking a subdivision of T , it follows that Γ also admits an action on a tree *without inversions* with amenable vertex stabilizers. In other words, Γ is the fundamental group of a graph of groups with amenable vertex groups.

¹One should note that it is not entirely clear whether conditions (i) and (iii) of [38, Theorem 1] actually exclude each other as the argument for this part [38, Section 2.2] is incomplete [35, p. 74]

5. RIGHT-ANGLED ARTIN GROUPS

We derive vanishing results for cup products of median classes of right-angled Artin groups, considering the action on the universal covering of their Salvetti complexes. Moreover, we give examples of median classes of right-angled Artin groups that are non-trivial in bounded cohomology.

5.1. RAAGs and the Salvetti complex. We first recall basic definitions and refer the reader to the literature [14] for more details.

If G is a finite unoriented simplicial graph, the corresponding *right-angled Artin group (RAAG)* $\Gamma := A(G)$ is the group with presentation

$$\langle V(G) \mid [v, w] = 1 : \{v, w\} \in E(G) \rangle.$$

The corresponding presentation complex is a square complex, and gluing higher-dimensional cubes for each clique in G provides a compact non-positively curved cube complex, called the *Salvetti complex* $S(G)$. The universal covering $\tilde{S}(G)$ of $S(G)$ is a finite-dimensional CAT(0) cube complex, on which Γ acts simplicially, freely, and cocompactly. We will denote it simply by X , and let V be its vertex set. Because the action is free, the orbit maps induce isomorphisms $H_{\Gamma, b}^*(X; \mathbb{R}) \cong H_b^*(\Gamma; \mathbb{R})$ (Theorem 2.2). Moreover, $S(G)$ is a model of $K(\Gamma, 1)$ (we will not use this fact directly). More importantly, let us recall that $S(G)$ satisfies the relevant finiteness conditions:

Remark 5.1. Salvetti complexes of finite unoriented simplicial graphs are finite-dimensional and have finite staircase length [18, Lemma 4.17].

Given an edge e of X , the projection of e to $S(G)$ is one of the edges of the original presentation complex, and so has a label $\lambda(e) \in V(G)$. This label is preserved by the action of Γ . Moreover, if e is dual to a halfspace h , then $\lambda(h) := \lambda(e)$ is well-defined (this can be seen from an alternative description of $\tilde{S}(G)$ [14, Section 3.6]).

In the following, we will always consider this setup:

Setup 5.2. Let Γ be the RAAG associated with a finite unoriented simplicial graph G and let $X := \tilde{S}(G)$ be the universal covering of the Salvetti complex.

The following lemma collects several properties given in Setup 5.2.

Lemma 5.3. *In the situation of Setup 5.2, we have:*

- (1) *Let h, k be halfspaces in X . Then the following are equivalent:*
 - (a) *There exists $\gamma \in \Gamma$ with $h \cap \gamma k$.*
 - (b) *The vertices $\lambda(h)$ and $\lambda(k)$ of G are distinct and connected by an edge.*
- (2) *Let h, k be halfspaces of X such that $h \supset k$ is tightly nested. Then $\{\lambda(h), \lambda(k)\}$ is independent in G .*
- (3) *Let $\gamma \in \Gamma$ be represented by a reduced word w in $V(G)^\pm$ such that every two consecutive letters of w are either equal or do not commute with each other. Then for all $x \in X(0)$, there is a unique geodesic in X from x to γx and the sequence of labels on the edges occurring in this geodesic is given by w .*

Proof. To prove Item 1, we first assume that $\lambda(h)$ and $\lambda(k)$ are distinct and connected by an edge. Then there is square in X whose boundary consists of two edges with label $\lambda(h)$ and two edges with label $\lambda(k)$. Let e_h and e_k be such edges with $\lambda(e_h) = \lambda(h)$ and $\lambda(e_k) = \lambda(k)$, respectively. By construction, the hyperplanes dual to these edges are transverse to each other. As X is the universal covering of $S(G)$, there is exactly one Γ -orbit of edges for each vertex in $v \in V(G)$; such an orbit consists of all edges e in X with label $\lambda(e) = v$. This implies that there are $\gamma_1, \gamma_2 \in \Gamma$ such that $\{\gamma_1 h, \overline{\gamma_1 h}\}$ is the hyperplane dual to the edge e_h and such that $\{\gamma_2 k, \overline{\gamma_2 k}\}$ is the hyperplane dual to the edge e_k . In particular, we then have $\gamma_1 h \pitchfork \gamma_2 k$, so $h \pitchfork \gamma_1^{-1} \gamma_2 k$.

To show the reverse implication of Item 1, let h, k be halfspaces in X and $\gamma \in \Gamma$ such that $h \pitchfork \gamma k$. By Lemma 3.4, there is a quadrangle $e_H, f_H, e_{\gamma K}, f_{\gamma K}$ such that e_H, f_H are dual to the hyperplane $H := \{h, \overline{h}\}$ and such that $e_{\gamma K}, f_{\gamma K}$ are dual to the hyperplane $\gamma K := \{\gamma k, \overline{\gamma k}\}$. As X is CAT(0), this quadrangle forms the boundary of a 2-cube in X [56, Lecture 2]. This implies that $\lambda(H)$ and $\lambda(\gamma K) = \lambda(K)$ form a clique in G , i.e., these vertices are connected by an edge.

Regarding Item 2, Fernós–Forrester–Tao show that if $h \supset k$ is tightly nested, then there is no $\gamma \in \Gamma$ such that $h \pitchfork \gamma h$ [17, Lemma 7.3, cf. Definition 7.1.(2)]. By Item 1, this implies that $\{\lambda(h), \lambda(k)\}$ is an independent set in G (consisting of one or two vertices).

Item 3 follows from canonical forms of words in RAAGs [14, Section 2.3]. \square

5.2. Vanishing cup products on RAAGs. We apply Theorem 3.23 and Theorem 3.25 to RAAGs.

Corollary 5.4. *In the situation of Setup 5.2, let $l \in \mathbb{N}$ and let $s = (h_1 \supset \dots \supset h_l) \in X_{\mathcal{H}}^{(l)}$. If $\lambda(h_1)$ and $\lambda(h_l)$ are isolated vertices of G , then every $\kappa \in C_{\Gamma, b}^n(V; \mathbb{R})$ is non-transverse to Γs . In particular, for every $\zeta \in H_{\Gamma, b}^n(X; \mathbb{R})$, we have*

$$[\delta^1 f_s] \cup \zeta = 0 \in H_{\Gamma, b}^{n+2}(X; \mathbb{R}).$$

Proof. The finiteness conditions on X are satisfied (Remark 5.1).

As in the case of trees, non-transversality is automatic if heads and tails of segments are unique. The highest dimension of a cube containing an edge e of X equals the highest cardinality of a clique in G containing $\lambda(e)$. In particular, if $\lambda(e)$ is isolated in G , then by definition, no edge in $S(G)$ with label $\lambda(e)$ is contained in a higher-dimensional cube. Hence the same is true for all such edges in the universal covering X , which implies that each of the two halfspaces dual to e has a unique head and a unique tail. Moreover, this property is preserved by the action of Γ . This proves the non-transversality claim.

We can then apply Theorem 3.23 to obtain the vanishing result. \square

Applying Theorem 3.25 to the setting of RAAGs, we obtain:

Corollary 5.5. *In the situation of Setup 5.2, let $l \in \mathbb{N}$, let $s = (h_1 \supset \dots \supset h_l) \in X_{\mathcal{H}}^{(l)}$, and $r = (k_1 \supset \dots \supset k_p) \in X_{\mathcal{H}}^{(p)}$. Suppose that each of the four*

pairs $\lambda(h_1), \lambda(k_1); \lambda(h_1), \lambda(k_p); \lambda(h_l), \lambda(k_1); \lambda(h_l), \lambda(k_p)$ are not connected by an edge in G . Then

$$[\delta^1 f_s] \cup [\delta^1 f_r] = 0 \in \mathbb{H}_{\Gamma, b}^4(X; \mathbb{R}).$$

Proof. The finiteness conditions on X are satisfied (Remark 5.1). The characterisation of Item 1 of Lemma 5.3 shows that in this situation the non-transversality hypothesis of Theorem 3.25 is satisfied. Applying Theorem 3.25 to the action of Γ on X proves the claim. \square

Again, let us remark that although the definition of non-transversality is more natural at the level of the action, the orbit map gives a canonical isomorphism $\mathbb{H}_{\Gamma, b}^n(X; \mathbb{R}) \cong \mathbb{H}_b^n(\Gamma; \mathbb{R})$, and so Corollaries 5.4 and 5.5 are actually statements about the usual bounded cohomology of RAAGs.

5.3. Non-trivial median classes in RAAGs. Finally, we show that there is a wealth of median classes on RAAGs that are non-trivial in bounded cohomology.

Every halfspace in X induces an orientation on its dual edges. Now every *oriented* edge in X determines an element in

$$V(G)^\pm = \{v \mid v \in V(G)\} \cup \{v^{-1} \mid v \in V(G)\}.$$

Hence, an \mathcal{H} -segment $s \in X_{\mathcal{H}}^{(l)}$ determines a sequence $\lambda^\pm(s)$ of such elements. It is easy to see that this sequence is reduced, so contains no subsequence of the form vv^{-1} or $v^{-1}v$. Hence, $\lambda^\pm(s)$ is a reduced word representing an element of Γ . Similarly, every geodesic in X defines a reduced word in $V(G)^\pm$. However, one should be aware that $\lambda^\pm(x)$ does not necessarily determine the orbit Γx completely.

To show non-triviality of certain median classes, we use free subgroups Λ of Γ . Let us recall that a set of vertices of a graph is *independent* if the graph does not contain an edge between any two of the vertices in this set. Whenever $F \subset V(G)$ is independent, it spans a free subgroup $\Lambda := \langle F \rangle$ of Γ . (These are often called *parabolic* or *graphical* free subgroups.)

There are two canonical ways of relating the bounded cohomology of Γ with the one of Λ : The group Λ is a retract of Γ and so $\mathbb{H}_b^*(\Lambda; \mathbb{R})$ is a retract of $\mathbb{H}_b^*(\Gamma; \mathbb{R})$. More explicitly: On the one hand, the inclusion $i: \Lambda \hookrightarrow \Gamma$ induces a *restriction map*

$$(3) \quad \mathbb{H}_b^2(i; \mathbb{R}): \mathbb{H}_b^2(\Gamma; \mathbb{R}) \rightarrow \mathbb{H}_b^2(\Lambda; \mathbb{R}).$$

On the other and, there is a canonical epimorphism $p: \Gamma \rightarrow \Lambda$ that is given by the identity on $\Lambda \leq \Gamma$ and sends every other generator $v \in V(G) \setminus F$ to the identity. This induces a *pullback map*

$$(4) \quad \mathbb{H}_b^2(p; \mathbb{R}): \mathbb{H}_b^2(\Lambda; \mathbb{R}) \rightarrow \mathbb{H}_b^2(\Gamma; \mathbb{R}).$$

We first use the restriction map (Equation (3)) to show that there are large classes of non-trivial median classes on RAAGs to which our results apply (Proposition 5.7, Proposition 5.9). We later show that these classes are not pullbacks of Brooks quasimorphisms (Proposition 5.10).

Let $w \in \Lambda$ be a reduced word with respect to the basis F . Then as explained by Fernós–Forrester–Tao [17, proof of Proposition 4.7], for every vertex $x \in X(0)$, there exists a sequence $s(w)$ of tightly nested halfspaces

in X that has $x \in \alpha(s(w))$ as a head and such that $\lambda^\pm(s(w)) = w$. Similarly to the non-overlapping case considered by Fernós–Forrester–Tao [17, proof of Proposition 4.7], one can show that $f_{s(w),x}$ restricts to the Brooks quasimorphism H_w on Λ . This is in fact true for every segment s that has x as a head and such that $\lambda^\pm(s) = w$:

Lemma 5.6 ([17, proof of Proposition 4.7]). *In the situation of Setup 5.2, let $F \subset V(G)$ be independent and $\Lambda := \langle F \rangle$. Let $x \in X(0)$ and s an \mathcal{H} -segment that has x as a head: $x \in \alpha(s)$. Then*

$$f_{s,x}|_\Lambda = H_w,$$

where $w := \lambda^\pm(s)$ and $H_w: \Lambda \rightarrow \mathbb{R}$ is the big Brooks quasimorphism associated to w .

Now we choose $x \in X(0)$ and consider the following subspace of $H_b^2(\Gamma; \mathbb{R})$:

$$B_F := \{[\delta^1 \widehat{f_{s,x}}] \mid l \in \mathbb{N}, s = (h_1 \supset \cdots \supset h_l) \in X_{\mathcal{H}}^{(l)}, \text{ and } \lambda(h_1), \lambda(h_l) \in F\}$$

If F is an independent subset of G , then on the one hand, our results show that the cup product is trivial on B_F (Corollary 5.5); on the other hand, we can use Lemma 5.6 to show that the subspace B_F is very big:

Proposition 5.7. *In the situation of Setup 5.2, if $F \subset V(G)$ is an independent set of vertices in G and $|F| \geq 2$, then $\dim B_F = \infty$ and for all $\varphi, \psi \in B_F$, we have*

$$\varphi \cup \psi = 0 \in H_b^4(\Gamma; \mathbb{R}).$$

Proof. For the infinite-dimensionality, we follow the argument from the non-overlapping case [17, Proposition 4.7]: Let $\{a, b\}$ be a two-element subset of F . Then, the subgroup $\Lambda \subset \Gamma$ generated by $\{a, b\}$ is free. It suffices to show that the restriction $H_b^2(\Gamma; \mathbb{R}) \rightarrow H_b^2(\Lambda; \mathbb{R})$ maps B_F to an infinite-dimensional subspace of $H_b^2(\Lambda; \mathbb{R})$. Let $w \in \Lambda$ a reduced word with respect to $\{a, b\}$. As noted above, there exists an \mathcal{H} -segment $s(w)$ in X that has some vertex x as a head and such that the median quasimorphism $f_{s(w),x}$ on Γ restricts to the (big) Brooks quasimorphism of w on Λ (Lemma 5.6). The set of (big) Brooks quasimorphisms on Λ spans an infinite-dimensional subspace of $H_b^2(\Lambda; \mathbb{R})$ [7, 29] (see also Proposition 2.6). By construction, the restriction maps B_F onto this subspace. Hence, $\dim B_F = \infty$.

That the cup product vanishes on B_F is an immediate consequence of Corollary 5.5. \square

Remark 5.8. In the case in which $F = \{v\}$ is a single vertex that is not central in $\Gamma = A(G)$, we still obtain the same result. Indeed, suppose that $v' \in V(G)$ is another vertex such that $F' = \{v, v'\}$ is independent. Then the previous lemma shows that $B_{F'}$ is infinite-dimensional, by pairing each element with a Brooks quasimorphism of the free group on $\{v, v'\}$. If we only consider those Brooks quasimorphisms that start and end with v , then we obtain elements in B_F , which are still non-trivial. These witness that the space is infinite-dimensional [29].

It is possible to choose such a v' , unless v is central. But the latter case is of little interest, since then the canonical epimorphism $A(G) \rightarrow A(G \setminus \{v\})$ induces an isomorphism $H_b^*(A(G \setminus \{v\}); \mathbb{R}) \rightarrow H_b^*(A(G); \mathbb{R})$ in

bounded cohomology. This follows directly by applying Gromov's Mapping Theorem [31][23, Section 5.5].

We point out that every non-trivial element of a RAAG is detected by the homogenisation of a median quasimorphism fitting in one of the subspaces B_F above (Proposition 5.9). Together with Proposition 5.10 this indicates that median quasimorphisms form a rich class of quasimorphisms on RAAGs.

Recall that if Γ is a group, the map δ^1 induces an isomorphism between the space of homogeneous quasi-morphisms of Γ and the kernel of the comparison map (see Proposition 2.6). For a quasimorphism $f: \Gamma \rightarrow \mathbb{R}$, let \bar{f} be the *homogenisation* of f , i.e., the quasimorphism defined by $\bar{f}(\gamma) := \lim_{n \rightarrow \infty} f(\gamma^n)/n$ for all $\gamma \in \Gamma$.

Proposition 5.9. *In the situation of Setup 5.2, let $\gamma \in \Gamma \setminus \{1\}$ and $x \in X(0)$. Then there exists an $l \in \mathbb{N}$ and a segment $s = (h_1 \supset \cdots \supset h_l) \in X_{\mathcal{H}}^{(l)}$ such that $\bar{f}_{s,x}(\gamma) \geq 1$ and such that $\{\lambda(h_1), \lambda(h_l)\}$ is an independent set in G .*

Proof. Call a segment $s = (h_1 \supset \cdots \supset h_l)$ γ -nested if $h_l \supset \gamma h_1$, i.e. if s and γs assemble to a segment $(h_1 \supset \cdots \supset h_l \supset \gamma h_1 \supset \cdots \supset \gamma h_l)$. Let s be a maximal γ -nested segment in $[x, \gamma x]_{\mathcal{H}}$.

Föhn proves [19, Lemma 4 and Proof of Theorem 15] that for all $n \geq 1$, the number of non-overlapping translates of s in $[x, \gamma^n x]_{\mathcal{H}}$ is at least n and that $[x, \gamma^n x]_{\mathcal{H}}$ contains no translate of \bar{s} . This implies that $f_s(x, \gamma^n x)$, which is the number of (possibly overlapping) translates of s in $[x, \gamma^n x]_{\mathcal{H}}$ minus the number of translates of \bar{s} in $[x, \gamma^n x]_{\mathcal{H}}$, is at least n . In particular, $\bar{f}_{s,x}(\gamma) = \lim_{n \rightarrow \infty} f_s(x, \gamma^n x)/n \geq 1$.

Furthermore, whenever $s = (h_1 \supset \cdots \supset h_l)$ is maximally γ -nested, then $h_l \supset \gamma h_1$ is tightly nested [19, Lemma 12]. So Item 2 of Lemma 5.3 implies that $\{\lambda(h_1), \lambda(h_l)\}$ is independent. \square

5.4. Comparison with pullbacks of Brooks quasimorphisms. The non-trivial median classes described above are genuinely related to the cubical (or median) structure of the CAT(0) cube complex and not just equal to the classes that one obtains as pullbacks of Brooks quasimorphisms via Equation (4).

Proposition 5.10. *In the situation of Setup 5.2, let s be an \mathcal{H} -segment, and suppose that one of the following holds:*

- (1) *The set of labels of halfspaces in s is not independent in G ;*
- (2) *The set of labels of halfspaces in s is an independent set $F \subset V(G)$ of size $2 \leq |F| < |V(G)|$, such that $\Lambda := \langle F \rangle$ is not a direct factor of Γ , and $\lambda^{\pm}(s)$ is cyclically reduced.*

Then for every $x \in X(0)$, the quasimorphism $f_{s,x}$ is not at bounded distance from the pullback of a non-zero Brooks quasimorphism on a parabolic free subgroup.

Remark 5.11. We formulated assumption (2) in order to have a comparably short proof that still witnesses that many median classes are not at a bounded distance from pullbacks of Brooks quasimorphisms. However this assumption is by no means necessary. For instance, with some more

work, one can drop the assumption that $\lambda^\pm(s)$ is cyclically reduced. On the other hand, the hypothesis that Λ is not a direct factor is necessary (see Example 3.19).

Proof of Proposition 5.10. We first show (by contraposition) that Assumption (1) implies the conclusion. Let s be an \mathcal{H} -segment of X and assume that the conclusion does not hold. Then there exist $x \in X(0)$, a parabolic subgroup $\Lambda = \langle F \rangle$ and a word $w \in \Lambda$ such that $f_{s,x}$ is at a bounded distance from $\tilde{H}_w := H_w \circ p$, where $p : \Gamma \rightarrow \Lambda$ is the retraction and H_w is non-zero. Since $H_w|_\Lambda$ is unbounded, $f_{s,x}|_\Lambda$ is also unbounded. Now, if $\gamma \in \Lambda$, then by Item 3 of Lemma 5.3 there is a unique geodesic from x to γx , and the sequence of labels on the edges of this geodesic describes a reduced word in F^\pm representing γ . This implies that every halfspace h in $[x, \gamma x]_{\mathcal{H}}$ has label $\lambda(h) \in F$. In particular, $[x, \gamma x]_{\mathcal{H}}$ can only contain a translate of s or of \bar{s} if every element of $\lambda^\pm(s)$ is contained in F^\pm . This shows that $\lambda^\pm(s)$ describes a word in Λ , so the set of labels of halfspaces of s is independent in G .

We now show that Assumption (2) implies the conclusion. Let $x \in X(0)$ and let s be an \mathcal{H} -segment such the set of labels of halfspaces in s is an independent set $F \subset V(G)$ with $|F| \geq 2$, such that $\lambda^\pm(s)$ is cyclically reduced, and such that $\Lambda := \langle F \rangle$ is not a direct factor of Γ .

Assume for a contradiction that $f_{s,x}$ is at a bounded distance from the pullback of a Brooks quasimorphism on a parabolic free subgroup Λ' . The proof of Proposition 5.10 with hypothesis (1) shows that then $\lambda^\pm(s) \in \Lambda'$. Moreover, Lemma 5.6 implies that $f_{s,x}|_{\Lambda'} = H_{\lambda^\pm(s)}$, which combined with Lemma 2.5 lets us assume that $\Lambda = \Lambda'$ and $f_{s,x}$ is at a bounded distance from \tilde{H}_w with $w = \lambda^\pm(s) \in \Lambda$ and $\tilde{H}_w = H_w \circ p$, where $p : \Gamma \rightarrow \Lambda$ is the retraction.

Assumption (2) also tells us that every element of F occurs in $\lambda(s)$, and that Λ is not a direct factor of Γ . Therefore there exist $v \in F$ and $v' \in V(G) \setminus F$ such that v and v' are not connected by an edge. There is a cyclic permutation of w of the form $\tilde{w} = v^l w v^{-l}$ with $l \in \mathbb{Z}$ and such that \tilde{w} does not end with v or v^{-1} .

Up to an automorphism we may assume that the first occurrence of v or v^{-1} in \tilde{w} is v . This implies that w neither starts nor ends with v^{-1} . We may write

$$\tilde{w} = w_1 v^k w_2,$$

where $k > 0$, where w_1 does not contain v or v^{-1} and w_2 does not start with v or v^{-1} . (By our assumption on \tilde{w} , the word w_2 also does not end with v or v^{-1} .) We note the following:

(5) If w_1 is non-trivial, then $\tilde{w} = w$.

(6) w_2 is a subword of w .

Let

$$w' := w_1 v^{-k} v' v^{3k} v' v^{-k} w_2.$$

Then w' is a reduced expression such that each two consecutive letters appearing in it are either equal to one another or do not commute. Moreover, since w is cyclically reduced, the same holds for powers of w' .

We claim that for no $n \geq 1$, the power $(w')^n$ contains a copy of w or w^{-1} : First assume that w is a subword of $(w')^n$ for some $n \geq 1$. Then as w does not contain v' , it must be a subword of $v^{-k}w_2w_1v^{-k}$. But as noted above, w neither starts nor ends with v^{-1} , so this implies that w is a subword of w_2w_1 . This is impossible because $\text{len}(w) = \text{len}(\tilde{w}) > \text{len}(w_2w_1)$. Now assume that w^{-1} is contained in $(w')^n$. Then again, it must be contained in $v^{-k}w_2w_1v^{-k}$, which is equivalent to w being a subword of $v^kw_1^{-1}w_2^{-1}v^k$. If w_1 is non-trivial, by Equation (5), the word $w = \tilde{w}$ neither starts nor ends with v . Hence, the inequality $\text{len}(w) > \text{len}(w_2w_1) = \text{len}(w_1^{-1}w_2^{-1})$ again gives a contradiction. If on the other hand w_1 is trivial, then w is a subword of $v^kw_2^{-1}v^k$. By Equation (6), the same is true for w_2 . As w_2 is not a power of v , this implies that w_2 and w_2^{-1} overlap, which is impossible (see, e.g., [20, Lemma 3.14]).

It follows that $f_{s,x}((w')^n) = 0$ for all $n \in \mathbb{N}$. Indeed, as noted above, $(w')^n$ is a reduced expression such that each two consecutive letters appearing in it are either equal to one another or do not commute. Hence, by Item 3 of Lemma 5.3, there is a unique geodesic in X from x to $(w')^nx$ and the sequence of labels of its edges is given by $(w')^n$. This implies that for every \mathcal{H} -segment t contained in $[x, (w')^nx]_{\mathcal{H}}$, the sequence $\lambda^{\pm}(t)$ must be a subword of $(w')^n$. However, we showed in the previous paragraph that $(w')^n$ contains no copy of $w = \lambda^{\pm}(s)$ or $w^{-1} = \lambda^{\pm}(\bar{s})$. Hence, no translate of s or \bar{s} is contained in $[x, (w')^nx]_{\mathcal{H}}$.

On the other hand, the epimorphism $p: \Gamma \rightarrow \Lambda$ sends w' to \tilde{w} . So, we obtain $\tilde{H}_w((w')^n) = H_w(\tilde{w}^n) \geq n - 1$ because \tilde{w} is a cyclic permutation of the letters of w , the word w is cyclically reduced and no occurrence of w^{-1} can overlap with w . Hence $f_{s,x}$ and \tilde{H}_w are not at bounded distance, which is a contradiction. \square

APPENDIX A. CUP PRODUCTS AND Lex

Group epimorphisms induce injections on the level of bounded cohomology in degree 2 [3][23, Section 2.7]. It is not known whether this behaviour persists in higher degrees. We explain how vanishing results for cup products have the potential to lead to non-examples in degree 4 and all degrees ≥ 6 .

Definition A.1. Let **Lex** be the class of all groups Λ with the following property: For all groups Γ and all epimorphisms $f: \Gamma \rightarrow \Lambda$, the induced map $H_b^*(f; \mathbb{R}): H_b^*(\Lambda; \mathbb{R}) \rightarrow H_b^*(\Gamma; \mathbb{R})$ is injective.

Bouarich shows that this class **Lex** contains many geometrically defined groups (e.g., free and surface groups) and that **Lex** is closed with respect to several “amenable” constructions [4]. Moreover, the class **Lex** has been studied in the context of boundedly acyclic groups [21]. It seems likely that not every group is in **Lex**, but no examples seem to be known.

Our recipe relating cup products to **Lex** relies on the interaction between bounded cohomology and ℓ^1 -homology. The ℓ^1 -homology functor $H_*^{\ell^1}(\cdot; \mathbb{R})$ is defined as the homology of the ℓ^1 -completion of the homogeneous complex on groups (or equivalently of the ℓ^1 -completion of the singular chain complex of classifying spaces) [48, 42]. For a group Γ , evaluation of bounded cocycles on ℓ^1 -cycles leads to a natural bilinear map $\langle \cdot, \cdot \rangle: H_b^*(\Gamma; \mathbb{R}) \times H_*^{\ell^1}(\Gamma; \mathbb{R}) \rightarrow \mathbb{R}$.

Definition A.2 (ℓ^1 -detectable). Let Γ be a group and $n \in \mathbb{N}$. A class $\varphi \in H_b^n(\Gamma; \mathbb{R})$ is ℓ^1 -detectable if there exists an $\alpha \in H_n^{\ell^1}(\Gamma; \mathbb{R})$ with $\langle \varphi, \alpha \rangle \neq 0$.

Proposition A.3.

- (1) Cross-products of ℓ^1 -detectable classes are ℓ^1 -detectable and hence non-trivial.
- (2) All non-trivial classes in $H_b^2(\cdot; \mathbb{R})$ are ℓ^1 -detectable.
- (3) If M is an oriented closed connected hyperbolic manifold of dimension $n \geq 2$, then there exists an ℓ^1 -detectable class in $H_b^n(\pi_1(M); \mathbb{R})$.

Proof. The first part follows from the fact that cross products are multiplicative with respect to evaluation in the sense that

$$\langle \varphi \times \psi, \alpha \times \beta \rangle = \pm \langle \varphi, \alpha \rangle \cdot \langle \psi, \beta \rangle$$

holds for all bounded cohomology classes φ, ψ and all ℓ^1 -homology classes α, β in compatible degrees [43, Proposition 2.5].

The second part follows from an observation by Matsumoto and Morita [48, Corollary 2.7, Theorem 2.3].

The third part is a consequence of the duality principle and the fact that the simplicial volume of oriented closed connected hyperbolic manifolds is non-zero [31]. Thus, the dual fundamental class is in the image of the comparison map and the fundamental class witnesses ℓ^1 -detectability. \square

Theorem A.4. Let $\Lambda_1, \Lambda_2, \Lambda_3$ be groups. We consider the (co)product groups $\Gamma := (\Lambda_1 * \Lambda_2) \times \Lambda_3$ and $\Lambda := (\Lambda_1 \times \Lambda_2) \times \Lambda_3$ and the group homomorphism

$$f := ((f_1, f_2) \circ \Delta) \times \text{id}_{\Lambda_3} : \Gamma \rightarrow \Lambda$$

given by the projections $f_j : \Gamma \rightarrow \Lambda_j$ to the first and second free factor, respectively, and the diagonal $\Delta : \Gamma \rightarrow \Gamma \times \Gamma$. Furthermore, we assume that there exist $n_1, n_2, n_3 \in \mathbb{N}$ with $n_1 + n_2 + n_3 = n$ and bounded cohomology classes $\varphi_j \in H_b^{n_j}(\Lambda_j; \mathbb{R})$ for each $j \in \{1, 2, 3\}$ with the following properties:

- (D) The classes $\varphi_1, \varphi_2, \varphi_3$ are ℓ^1 -detectable.
- (C) We have $H_b^{n_1}(f_1; \mathbb{R})(\varphi_1) \cup H_b^{n_2}(f_2; \mathbb{R})(\varphi_2) = 0 \in H_b^n(\Gamma; \mathbb{R})$.

Then $H_b^n(f; \mathbb{R})$ is not injective. In particular, the group Λ is not in Lex.

Proof. Under these hypotheses, the class $\varphi := \varphi_1 \times \varphi_2 \times \varphi_3 \in H_b^n(\Lambda; \mathbb{R})$ witnesses that $H_b^n(f; \mathbb{R})$ is not injective:

- The ℓ^1 -detectability (D) and Proposition A.3 imply $\varphi \neq 0$ in $H_b^n(\Lambda; \mathbb{R})$.
- Moreover, property (C) and the relation between the cup and the cross product allow us to compute that

$$\begin{aligned} & H_b^{n_1+n_2}((f_1, f_2) \circ \Delta; \mathbb{R})(\varphi_1 \times \varphi_2) \\ &= H_b^{n_1+n_2}(\Delta; \mathbb{R})(H_b^{n_1}(f_1; \mathbb{R})(\varphi_1) \times H_b^{n_2}(f_2; \mathbb{R})(\varphi_2)) \\ &= H_b^{n_1}(f_1; \mathbb{R})(\varphi_1) \cup H_b^{n_2}(f_2; \mathbb{R})(\varphi_2) \\ &= 0. \end{aligned}$$

In particular, we obtain

$$\begin{aligned} H_b^n(f; \mathbb{R})(\varphi) &= H_b^{n_1+n_2}((f_1, f_2) \circ \Delta; \mathbb{R})(\varphi_1 \times \varphi_2) \times H_b^{n_3}(\text{id}_{\Lambda_3}; \mathbb{R})(\varphi_3) \\ &= 0 \times \varphi_3 = 0. \end{aligned}$$

Therefore, $H_b^n(f; \mathbb{R}): H_b^n(\Lambda; \mathbb{R}) \rightarrow H_b^n(\Gamma; \mathbb{R})$ is *not* injective.

By construction, f is an epimorphism. Therefore, the non-injectivity of $H_b^n(f; \mathbb{R})$ shows that Λ is not in Lex. \square

What are candidates for finding groups and classes as in Theorem A.4? It is tempting to consider the following situation: Let $n \in \{4\} \cup \mathbb{N}_{\geq 6}$. We set $n_1 := 2$, $n_2 := 2$, and $n_3 := n - 4$.

- If $n = 4$, then we take Λ_3 as the trivial group; then, every $\varphi_3 \in H_b^0(\Lambda_3; \mathbb{R}) \setminus \{0\}$ is ℓ^1 -detectable.
If $n \geq 6$, then we choose Λ_3 as the fundamental group of an oriented closed connected hyperbolic $(n - 4)$ -manifold (such manifolds do exist); in view of Proposition A.3, there then also exists an ℓ^1 -detectable class $\varphi_3 \in H_b^{n_3}(\Lambda_3; \mathbb{R})$.
- Let $\Lambda_1 := F_2$, $\Lambda_2 := F_2$ and let $\varphi_1, \varphi_2 \in H_b^2(F_2; \mathbb{R})$ be classes corresponding to non-trivial quasi-morphisms, e.g., Brooks quasimorphisms or Rolli quasimorphisms. Then φ_1 and φ_2 are ℓ^1 -detectable (Proposition A.3).

What about property (C) from Theorem A.4? For $j \in \{1, 2\}$, the pull-back $H_b^2(f_j; \mathbb{R})(\varphi_j) \in H_b^4(F_2 * F_2; \mathbb{R})$ unfortunately does *not* obviously fall into one of the classes for which it is known that the cup products vanish (see, e.g., Proposition 5.10).

In summary, if $H_b^2(f_1; \mathbb{R})(\varphi_1) \cup H_b^2(f_2; \mathbb{R})(\varphi_2) \in H_b^4(F_4; \mathbb{R})$ were known to be zero, then we would have a rich class of examples of non-Lex groups.

REFERENCES

- [1] S. Amontova and M. Bucher. Trivial cup products in bounded cohomology of the free group via aligned chains. *Forum Math.*, 34(4):933–943, 2022. Cited on page: 2, 3, 20
- [2] M. Bestvina and K. Fujiwara. Bounded cohomology of subgroups of mapping class groups. *Geom. Topol.*, 6:69–89, 2002. Cited on page: 2
- [3] A. Bouarich. Suites exactes en cohomologie bornée réelle des groupes discrets. *C. R. Acad. Sci. Paris Sér. I Math.*, 320(11):1355–1359, 1995. Cited on page: 31
- [4] A. Bouarich. Exactitude à gauche du foncteur $H_b^n(-, \mathbb{R})$ de cohomologie bornée réelle. *Ann. Fac. Sci. Toulouse Math. (6)*, 10(2):255–270, 2001. Cited on page: 31
- [5] M. R. Bridson and A. Haefliger. *Metric spaces of non-positive curvature*, volume 319 of *Grundlehren der Mathematischen Wissenschaften [Fundamental Principles of Mathematical Sciences]*. Springer, 1999. Cited on page: 9
- [6] J. Brodzki, S. J. Campbell, E. Guentner, G. A. Niblo, and N. J. Wright. Property A and CAT(0) cube complexes. *J. Funct. Anal.*, 256(5):1408–1431, 2009. Cited on page: 16
- [7] R. Brooks. Some remarks on bounded cohomology. In *Riemann Surfaces Related Topics (AM-97)*, Volume 97, pages 53–64. Princeton University Press, 2016. Cited on page: 2, 28
- [8] M. Bucher and N. Monod. The cup product of Brooks quasimorphisms. *Forum Math.*, 30(5):1157–1162, 2018. Cited on page: 2, 3
- [9] M. Bucher and N. Monod. The bounded cohomology of SL_2 over local fields and S -integers. *Int. Math. Res. Not. IMRN*, (6):1601–1611, 2019. Cited on page: 3
- [10] M. Burger, A. Iozzi, N. Monod, and A. Wienhard. Bounds for cohomology classes. *Enseign. Math. (2)*, 54(1–2):3–189, 2008. Guido’s book of conjectures, A gift to Guido Mislin on the occasion of his retirement from ETHZ, June 2006, collected by I. Chatterji. Cited on page: 1
- [11] M. Burger and N. Monod. Continuous bounded cohomology and applications to rigidity theory. *Geom. Funct. Anal.*, 12(2):219–280, 2002. Cited on page: 1, 2

- [12] D. Calegari. *scl*, volume 20 of *MSJ Memoirs*. Mathematical Society of Japan, Tokyo, 2009. Cited on page: 1, 7
- [13] P. Capovilla, C. Löh, and M. Moraschini. Amenable category and complexity. *Alg. Geom. Topol.*, 22:1417–1459, 2022. Cited on page: 4, 8
- [14] R. Charney. An introduction to right-angled Artin groups. *Geom. Dedicata*, 125:141–158, 2007. Cited on page: 25, 26
- [15] I. Chatterji, T. Fernós, and A. Iozzi. The median class and superrigidity of actions on CAT(0) cube complexes. *J. Topol.*, 9(2):349–400, 2016. With an appendix by Pierre-Emmanuel Caprace. Cited on page: 3, 18
- [16] D. B. A. Epstein and K. Fujiwara. The second bounded cohomology of word-hyperbolic groups. *Topology*, 36(6):1275–1289, 1997. Cited on page: 2
- [17] T. Fernós, M. Forester, and J. Tao. Effective quasimorphisms on right-angled Artin groups. *Ann. Inst. Fourier*, 69(4):1575–1626, 2019. Cited on page: 2, 3, 4, 13, 18, 26, 27, 28
- [18] E. Fioravanti. Coarse-median preserving automorphisms. arXiv preprint arXiv:2105.02821, to appear in *Geom. Topol.* Cited on page: 12, 25
- [19] P. Föhn. A simplification of “Effective quasimorphisms on right-angled Artin groups”. arXiv preprint arXiv:1907.13317. Cited on page: 18, 29
- [20] F. Fournier-Facio. Infinite sums of Brooks quasimorphisms and cup products in bounded cohomology. arXiv preprint arXiv:2002.10323. Cited on page: 2, 4, 7, 31
- [21] F. Fournier-Facio, C. Löh, and M. Moraschini. Bounded cohomology of finitely presented groups: vanishing, non-vanishing, and computability. arXiv preprint: arXiv:2106.13567, to appear in *Ann. Sc. Norm. Sup. Pisa Cl. Sci.* Cited on page: 2, 31
- [22] F. Fournier-Facio, C. Löh, and M. Moraschini. Bounded cohomology and binate groups. *J. Aust. Math. Soc.*, 115(2):204–239, 2023. Cited on page: 2
- [23] R. Frigerio. *Bounded cohomology of discrete groups*, volume 227 of *Mathematical Surveys and Monographs*. American Mathematical Society, Providence, RI, 2017. Cited on page: 5, 6, 8, 29, 31
- [24] R. Frigerio, M. B. Pozzetti, and A. Sisto. Extending higher-dimensional quasicycles. *J. Topol.*, 8(4):1123–1155, 2015. Cited on page: 1
- [25] K. Fujiwara. The second bounded cohomology of a group acting on a Gromov-hyperbolic space. *Proc. London Math. Soc.*, 76(1):70–94, 1998. Cited on page: 2
- [26] K. Fujiwara. The second bounded cohomology of an amalgamated free product of groups. *Trans. Amer. Math. Soc.*, 352(3):1113–1129, 2000. Cited on page: 2
- [27] É. Ghys. Groupes d’homéomorphismes du cercle et cohomologie bornée. In *The Lefschetz centennial conference, Part III (Mexico City, 1984)*, volume 58 of *Contemp. Math.*, pages 81–106. Amer. Math. Soc., Providence, RI, 1987. Cited on page: 1
- [28] É. Ghys and V. Sergiescu. Sur un groupe remarquable de difféomorphismes du cercle. *Comment. Math. Helv.*, 62(1):185–239, 1987. Cited on page: 2
- [29] R. I. Grigorchuk. Some results on bounded cohomology. In *Combinatorial and geometric group theory (Edinburgh, 1993)*, volume 204 of *London Math. Soc. Lecture Note Ser.*, pages 111–163. Cambridge Univ. Press, Cambridge, 1995. Cited on page: 4, 28
- [30] R. I. Grigorchuk. Bounded cohomology of group constructions. *Mat. Zamet.*, 59(4):546–550, 1996. Cited on page: 2
- [31] M. Gromov. Volume and bounded cohomology. *Inst. Hautes Études Sci. Publ. Math.*, 56:5–99 (1983), 1982. Cited on page: 1, 5, 29, 32
- [32] M. Hagen. CAT(0) cube complexes, median graphs, and cubulating groups. Available at https://www.wescac.net/into_the_forest.pdf, accessed September 2022. Cited on page: 10
- [33] T. Hartnick and A. Talambutsa. Relations between counting functions on free groups and free monoids. *Groups Geom. Dyn.*, 12(4):1485–1521, 2018. Cited on page: 4
- [34] N. Heuer. Cup product in bounded cohomology of the free group. *Ann. Sc. Norm. Super. Pisa Cl. Sci. (5)*, 21:1–26, 2020. Cited on page: 2, 3, 20
- [35] F. Hofmann. Quasi-morphisms and bounded cohomology. MSc thesis, Universität Regensburg, 2023. Cited on page: 4, 24

- [36] C. H. Houghton. The first cohomology of a group with permutation module coefficients. *Arch. Math. (Basel)*, 31(3):254–258, 1978/79. Cited on page: 15
- [37] M. Hull and D. Osin. Induced quasicocycles on groups with hyperbolically embedded subgroups. *Algebr. Geom. Topol.*, 13(5):2635–2665, 2013. Cited on page: 1
- [38] A. Iozzi, C. Pagliantini, and A. Sisto. Characterising actions on trees yielding non-trivial quasimorphisms. *Ann. Math. Qué.*, 45(1):185–202, 2021. Cited on page: 3, 24
- [39] N. V. Ivanov. Foundations of the theory of bounded cohomology. volume 143, pages 69–109, 177–178. 1985. Studies in topology, V. Cited on page: 1, 5
- [40] K. Li. Bounded cohomology of classifying spaces for families of subgroups. *Algebr. Geom. Topol.*, 23(2):933–962, 2023. Cited on page: 2, 6, 8
- [41] K. Li, C. Löh, and M. Moraschini. Bounded acyclicity and relative simplicial volume. arXiv preprint: arXiv:2202.05606. Cited on page: 6
- [42] C. Löh. Isomorphisms in ℓ^1 -homology. *Münster J. Math.*, 1:237–265, 2008. Cited on page: 31
- [43] C. Löh. A note on bounded-cohomological dimension of discrete groups. *J. Math. Soc. Japan*, 69(2):715–734, 2017. Cited on page: 2, 9, 18, 32
- [44] C. Löh and R. Sauer. Bounded cohomology of amenable covers via classifying spaces. *Enseign. Math. (2)*, 66(1):151–172, 2020. Cited on page: 2, 6
- [45] A. V. Maljutin. Writhe of (closed) braids. *Algebra i Analiz*, 16(5):59–91, 2004. Cited on page: 2
- [46] D. Marasco. Cup product in bounded cohomology of negatively curved manifolds. arXiv preprint arXiv:2202.04419, to appear in *Proc. Amer. Math. Soc.* Cited on page: 2, 20
- [47] D. Marasco. Trivial Massey product in bounded cohomology. arXiv preprint arXiv:2209.00560. Cited on page: 4
- [48] S. Matsumoto and S. Morita. Bounded cohomology of certain groups of homeomorphisms. *Proc. Amer. Math. Soc.*, 94(3):539–544, 1985. Cited on page: 31, 32
- [49] N. Monod. *Continuous bounded cohomology of locally compact groups*, volume 1758 of *Lecture Notes in Mathematics*. Springer, 2001. Cited on page: 5
- [50] N. Monod and S. Nariman. Bounded and unbounded cohomology of homeomorphism and diffeomorphism groups. arXiv preprint: arXiv:2111.04365, to appear in *Invent. Math.* Cited on page: 2
- [51] N. Monod and Y. Shalom. Cocycle superrigidity and bounded cohomology for negatively curved spaces. *J. Differential Geom.*, 67(3):395–455, 2004. Cited on page: 2, 3, 24
- [52] N. Monod and Y. Shalom. Orbit equivalence rigidity and bounded cohomology. *Ann. of Math. (2)*, 164(3):825–878, 2006. Cited on page: 3
- [53] L. Polterovich and D. Rosen. *Function theory on symplectic manifolds*, volume 34 of *CRM Monograph Series*. American Mathematical Society, Providence, RI, 2014. Cited on page: 2
- [54] M. Roller. Poc sets, median algebras and group actions. arXiv preprint arXiv:1607.07747. Cited on page: 9
- [55] M. Sageev. Ends of group pairs and non-positively curved cube complexes. *Proc. London Math. Soc.*, 71(3):585–617, 1995. Cited on page: 10
- [56] M. Sageev. CAT(0) cube complexes and groups. In *Geometric group theory*, volume 21 of *IAS/Park City Math. Ser.*, pages 7–54. Amer. Math. Soc., Providence, RI, 2014. Cited on page: 9, 26
- [57] T. Soma. Bounded cohomology and topologically tame Kleinian groups. *Duke Math. J.*, 88(2):357–370, 1997. Cited on page: 1

DEPARTMENT FOR MATHEMATICAL LOGIC AND FOUNDATIONAL RESEARCH, UNIVERSITY OF MÜNSTER, GERMANY

Email address: `benjamin.brueck@uni-muenster.de`

DEPARTMENT OF PURE MATHEMATICS AND MATHEMATICAL STATISTICS, UNIVERSITY OF CAMBRIDGE, UK

Email address: `ff373@cam.ac.uk`

FAKULTÄT FÜR MATHEMATIK, UNIVERSITÄT REGENSBURG, REGENSBURG, GERMANY

Email address: `clara.loeh@ur.de`